



Realtech

www.realtechotomasyon.com.tr



İstanbul

Oruçreis Mah. Giyimkent 5. Sk.
Giyimkent B57 NO: 82/A
Esenler İstanbul / Türkiye

0 (212) 438 11 80
0 (533) 374 45 92

info@realtechotomasyon.com.tr

Gaziantep

Mücahitler Mah. 52008 Nolu Cad. No:3/J
Şehitkamil Gaziantep / Türkiye

0 (342) 503 11 83
0 (544) 948 40 40

ibrahim@realtechotomasyon.com.tr



PROGRAMMABLE CONTROLLER
FP0H Control Unit
User's Manual

EtherNet/IP

[Applicable models]
AFP0HC32ET/AFP0HC32EP

SAFETY PRECAUTIONS

To prevent accidents or personal injuries, please be sure to comply with the following items.
Prior to installation, operation, maintenance and check, please read this manual carefully for proper use.
Before using, please fully understand the knowledge related to the equipment, safety precautions and all other precautions.

Safety precautions are divided into two levels in this manual: Warning and Caution.



WARNING Incorrect operation may lead to death or serious injury.

- Take appropriate safety measures to the external circuit of the product to ensure the security of the whole system in case of abnormalities caused by product failure or external.
- Do not use this product in areas with inflammable gases.
Otherwise it may lead to an explosion.
- Do not put this product into a fire.
Otherwise it could cause damage to the battery or other electronic parts.
- Do not impact, charge or heat the lithium battery, and do not put it into a fire.
Otherwise it may lead to fire or damage.



CAUTION Incorrect operation may lead to injury or material loss.

- To prevent the excessive exothermic heat or smoke generation of the product, a certain margin is required for guaranteed characteristics and performance ratings of relative products.
- Do not decompose or transform it.
Otherwise it will lead to the excessive exothermic heat or smoke generation of the product.
- Do not touch terminal blocks during power-on.
Otherwise it may result in an electric shock.
- Set an emergency stop and interlock circuit in the external devices.
- Connect wires and connectors reliably.
Otherwise it may lead to the excessive exothermic heat or smoke generation of the product.
- Do not undertake construction (such as connection and disconnection) while the power supply is on.
It could lead to an electric shock.
- If the equipment is used in a manner not specified by the Panasonic, the protection provided by the equipment may be impaired.
- This product has been developed/produced for industrial use only.

Description on Copyright and Trademarks

- The copyright of this manual is owned by Panasonic Industrial Devices SUNX Co., Ltd.
- Unauthorized reproduction of this manual is strictly prohibited.
- Windows is a registered trademark of Microsoft Corporation in the U.S. and other countries.
- Ethernet is a registered trademark of Fuji Xerox Co., Ltd. and Xerox Corporation.
- EtherNet/IP is a registered trademark of ODVA (Open DeviceNet Vendor Association).
- Other company and product names are trademarks or registered trademarks of their respective companies.

Introduction

Thank you for buying a Panasonic product. Before you use the product, please carefully read the installation instructions and the users manual, and understand their contents in detail to use the product properly.

Types of Manual

- This manual describes the "EtherNet/IP communication function" implemented in FP0H Control Unit.
- There are different types of user's manual for the FP0H series. Please refer to a relevant manual for the unit and purpose of your use.
- The manuals can be downloaded on our website:
https://industrial.panasonic.com/ac/e/dl_center/manual/

Unit name or purpose of use	Manual name	Manual code
FP0H Control Unit	FP0H User's Manual (Basic)	WUME-FP0HBAS
	FP Series Programming Manual	ARCT1F313E
	FP0H Instruction Manual (SD Card Access Instructions)	WUME-FP0HSD
Positioning Function/PWM Output/High-speed Counter Function	FP0H User's Manual (Positioning/PWM Output/High-speed Counter)	WUME-FP0HPOS
Serial Communication Function	FP0H User's Manual (COM Communication)	WUME-FP0HCOM
Ethernet Communication Function	FP0H User's Manual (Ethernet Communication)	WUME-FP0HET
EtherNet/IP Communication Function	FP0H User's Manual (EtherNet/IP)	WUME-FP0HEIP
Logging trace function	FP0H User's Manual (Logging/Trace Function)	WUME-FP0HLOG
FP0H Extension (Communication) Cassette	FP0H User's Manual (COM Communication)	WUME-FP0HCOM
FP0H Positioning Unit RTEX	FP0H Positioning Unit RTEX User's Manual (FPWIN GR7)	WUME-FP0HRTEXGR7

Glossary

The following terms are used in this manual and the EtherNet/IP setting tool.

Term	Description
Originator	The side which opens the connection of the cyclic communication is called originator, i.e. controllers such as PLC.
Target	The side which the connection is opened is called target, such as PLC, I/O devices.
Scan List	Connection setting with targets registered in FP0H. Information required for the communication with the targets and the device allocation of own unit are registered. For FP0H, the connection with targets are established according to the scan list.
I/O map	Information required for the transmission from the own unit (FP0H) to other PLCs and the device allocation of the own unit are registered.
EDS file (Electric data sheet)	EDS files are provided for each product by each vendor. This file contains the information on the communication for registering targets in the scan list. The EDS files of each target should be registered for constructing the scan list with the setting tool.
Node no.	A node number is set when a target is registered in the scan list. Numbers that do not overlap are allocated in the scan list as node numbers. Node numbers are not used in the cyclic communication, however, as each target is recognized by these numbers, they are used for monitoring the communication state of each node or controlling the start/stop of the communication.
Connection setting	The details of the connections with targets registered in the scan list are set.
Node name	Arbitrary node names can be given.
Device name	Device names of targets. The device name is registered in the EDS file.
Connection Name	The type of the connection manager registered in the EDS file is selected by the name. By selecting this, the application type (communication method) is changed.
Application Type	The communication method can be selected by the application type. Three communication methods are available; 1: Exclusive Owner (Two-way communication) 2: Input Only 3: Listen Only Although "Exclusive Owner" and "Input Only" are independent connections, "Listen Only" can be connected only when either of the above connections is established, and it will be automatically cut if the independent connection is disconnected. Also, it will be reconnected automatically when the above independent connection is reconnected. When FP0H is used as a target, "Input Only" can be selected.
Compatibility Check	Set the operation method of "Compatibility Check", which checks the information of the connected target device against the revision of the EDS file. Three verification methods are available. The default is "Follow Adapter(Target) Rule". 1: Check 2: Not check 3: Follow Adapter(Target) Rule

Term	Description
Communication Method (Tag/Instance)	For connecting from an originator to target, there are two methods to specify the device area of the target. - by specifying numbers (Instance) - by specifying symbols (Tag). When setting connections, the methods available for each target are displayed. For using the FP0H as a target, either method can be selected. However, the selectable instance numbers for the instance method are 100 to 199.
Input Send Trigger	The transmission timing is selected from Cyclic or COS (Change of state). However, COS depends on devices. COS is basically a cyclic communication, however, it also performs transmission when sent data changes. The FP0H does not support COS.
COS Transmission Disable Time	Transmission disable time (RPI of input information x 1/4) is displayed when "Input Send Trigger" is set to "Change of State (COS)". Even if the unit detects the change in data, it is not sent within the transmission disable time.
Timeout Period	In the cyclic communication, transmission data is sent as UDP packet. The timeout is judged on a receiver side. The timeout period is selected from 4, 8, 16, 32, 64, 128, 256 and 512 times of RPI. The timeout period should be 10 msec or more. RPI can be specified for T>O direction and O>T direction separately, so each timeout period may be different values.
Input Information (T>O)	This is the setting for the transmission from a target to the FP0H (originator).
Output Information (O>T)	This is the setting for the transmission from the FP0H (originator) to a target.
RPI (Requested Packet Interval)	Set the transmission interval for the cyclic communication. Set a value within the communication capacity of a target. The usable RPI range depends on devices. For the FP0H, it is 1 ms to 10 s (by 0.5 ms).
Point to Point (1:1 communication)	One to one communication is performed between an originator and a target. Transmitted packets are received only by each other. Other devices connected to the same HUB do not receive those transmission packets.
Multicast (Multicast communication)	Transmission data is sent as a multicast packet. By connecting multiple originators to one target, one multicast packet can be received by multiple originators. (Note) Multicast packets are basically received by all devices connected to the same HUB which includes the devices unrelated to the communication, and it leads to an unnecessary communication load. When using the multicast communication, set not to exceed 100% by the load factor calculation of the setting tool.
TTL	TTL (Time To Live) is used to set the hierarchies of the network in which transmission packets can exist when sending multicast packets to other PLCs.
Instance ID/Tag name	Set an instance ID or tag name according to the communication method of the selected connection.
Data Size	The data sizes of the originator and target for the cyclic communication must be the same. When they do not match, the communication cannot be performed.
Parameter setting	Data size, instance ID and other parameters that can be changed in the EDS file can be changed.
PPS performance index (Packet per sec)	This is an index of sent/received packets processed in one second.

Glossary

Term	Description
Normal packet and large packet	<p>The packet whose size is within 510 bytes is called normal packet. The packet whose size is 511 bytes to 1444 bytes is called large packet.</p> <p>The maximum communication performance varies according to the data size used for communication.</p> <p>Performance index of FP0H For 510 bytes or less: Max. 5000 pps For 511 bytes or more: Max. 2500 pps</p>
Protocol used for cyclic communication	<p>The cyclic communication is performed using UDP. The used port number is 2222.</p>
Heartbeat	<p>For "Input Only" or "Listen Only", a packet called heartbeat whose data size is zero is sent from the originator (FP0H). For the RPI of the heartbeat, the value 16 times of the RPI of transmitted data from a target is automatically applied.</p> <p>The heartbeat is used for confirming the continuation of the connection on the target side. It is used for detect the timeout.</p>
Forward open	<p>This is a command for opening the connection of EtherNet/IP and sent using TCP. The used port number is 44818.</p>
Large forward open	<p>This is a command for opening the connection when sending/receiving data whose size is larger than 511 bytes.</p>
RUN/IDLE bit	<p>Operation state flag (RUN/IDLE) sent by connected devices in cyclic communication.</p> <p>RUN : 1 IDLE : 0</p> <p>When the RUN/IDLE bit of the originator does not change to RUN, the target may not operate properly. For details, refer to "5.2.3 RUN/IDLE Bit".</p>



NOTE

- **Do not use "2222" and "44818" for the port numbers set to the connections of Ethernet communication.**

Table of Contents

1. FP0H EtherNet/IP Function	1-1
1.1 What is EtherNet/IP?.....	1-2
1.1.1 Overview of EtherNet/IP	1-2
1.1.2 FP0H EtherNet/IP Function.....	1-2
1.2 Names and Functions of Parts	1-4
1.2.1 Control Unit	1-4
1.2.2 LED Displays When PLC Operates	1-5
1.3 Restrictions	1-7
2. Cyclic Communication.....	2-1
2.1 Cyclic Communication Function	2-2
2.1.1 Overview of Cyclic Communication.....	2-2
2.1.2 Operation of Cyclic Communication.....	2-3
2.1.3 Data Refresh of Cyclic Communication	2-4
2.1.4 Data Area Specifications Using Tag/Instance.....	2-5
2.2 Cyclic Communication of FP0H.....	2-6
2.2.1 Connection using FP0H as originator	2-6
2.2.2 Connection Using FP0H as Target	2-7
2.2.3 Example of Configuration When FP0H is Originator and Target.....	2-8
3. Setting Procedure	3-1
3.1 Overview of Settings	3-2
3.1.1 System Example	3-2
3.1.2 Setting Procedure.....	3-3

3.2	Initial Setting of Ethernet /IP	3-4
3.2.1	Ethernet Settings	3-4
3.2.2	Starting EtherNet/IP Setting Screen.....	3-5
3.2.3	EtherNet/IP Basic Configuration	3-6
3.2.4	Items of Ethernet /IP Basic Configuration	3-7
3.3	Settings of Connection Using FP0H as Originator	3-8
3.3.1	Settings.....	3-8
3.3.2	Registering EDS File of Target Device	3-9
3.3.3	Adding Target in Scan List	3-10
3.3.4	Setting IP Address of Target.....	3-11
3.3.5	Setting Tag/Instance	3-12
3.3.6	Specifying Data Area Corresponding to Tag/Instance	3-14
3.3.7	Reference: Setting of Target [FP0H(B)]	3-15
3.4	Settings of Connection Using FP0H as Target.....	3-16
3.4.1	Settings.....	3-16
3.4.2	Adding I/O Map to Scan List.....	3-17
3.4.3	Registering Tag Name/Instance ID	3-18
3.4.4	Registering Data Area Corresponding to Tag/Instance	3-19
3.4.5	Reference: Setting of Originator [FP7]	3-20
3.5	Confirmation of Load Factor Calculation	3-21
3.5.1	Load Factor Calculation	3-21
3.5.2	Displaying Load Factor Calculation.....	3-21
3.6	Saving EtherNet/IP Settings	3-22
3.6.1	Saving EtherNet/IP Settings in Project.....	3-22
3.6.2	Saving/Reading EtherNet/IP Settings in File.....	3-22
3.6.3	Writing EtherNet/IP Settings to FP0H	3-23
4.	Tool Operation	4-1
4.1	Scan List Window	4-2
4.1.1	Display Contents of Scan List Window	4-2
4.1.2	Operations in Scan List Window	4-3

4.2	Device List Window.....	4-7
4.2.1	Display Contents of Device List Window.....	4-7
4.2.2	Operations from EDS File Menu	4-8
4.3	Various Setting Screens.....	4-9
4.3.1	Operations in Device Setting Screen	4-9
4.3.2	Operations in Connection Setting Screen	4-10
4.3.3	Operations in I/O Map Setting Screen	4-14
4.3.4	Display Contents of Calculate Load Factor Screen	4-15
4.3.5	Display Contents of Device Property Screen.....	4-17
4.3.6	Switching Tabs in Each Setting Screen	4-18
5.	Startup and Operation	5-1
5.1	Startup Operation of Cyclic Communication.....	5-2
5.1.1	When FP0H is Originator	5-2
5.1.2	When FP0H is Target.....	5-4
5.2	Checking EtherNet/IP Communication State.....	5-5
5.2.1	Unit Annunciation Relays	5-5
5.2.2	Cyclic Communication State Tables of EtherNet/IP.....	5-5
5.2.3	RUN/IDLE Bit	5-6
5.3	Judgement and Operation of Abnormality	5-7
5.4	Delay Time of Communication Data.....	5-8
5.4.1	Delay time of sent data	5-8
5.4.2	Delay Time of Reception Data	5-9
6.	Instruction References	6-1
6.1	High-level Instructions Used for EtherNet/IP Control.....	6-2
6.1.1	Information Acquisition of EtherNet/IP (F465 ETSTAT).....	6-2

7. Reference Information.....	7-1
7.1 Calculation Method of Load Factor	7-2
7.2 Cyclic Communication: List of Abnormal Statuses	7-5
7.3 PLC Link and Ethernet Switch	7-7
8. Appendix	8-1
8.1 Supported Data Types.....	8-2

1

FP0H EtherNet/IP Function

1.1 What is EtherNet/IP?

1.1.1 Overview of EtherNet/IP

EtherNet/IP (Ethernet Industrial Protocol) is an industrial multi-vendor realtime Ethernet system for executing the communication protocol for CIP (Common Industrial Protocol) control in an application layer on standard Ethernet.

Cyclic communication can be performed among devices compatible with EtherNet/IP. In cyclic communication, devices compatible with EtherNet/IP send or receive data between "specified data areas" in a "specified cycle". Even when the number of nodes increases, the cycle does not increase.

For information on CIP, refer to the documents of ODVA.

1.1.2 FP0H EtherNet/IP Function

The FP0H can perform the cyclic communication with PLCs and I/O devices compatible with EtherNet/IP on the EtherNet/IP network.

The send and receive areas are allocated from the device area of the FP0H for the cyclic communication. Data is sent/received from the allocated area with specified intervals (RPI).

The EtherNet/IP function of FP0H is set from the "EtherNet/IP settings" menu of programming software FPWIN GR7.

■ Originator and Target

In each connection (communication line) of cyclic communication, there are "originator" which opens each connection and "target" which a connection is opened.

The PLC (FP0H) can be set as the both originator and target.

For the communication between the FP0H and a PLC, the settable connection is "Input Only" (i.e. data can be sent in one direction, from target to originator). By using two connections, data can be sent and received.

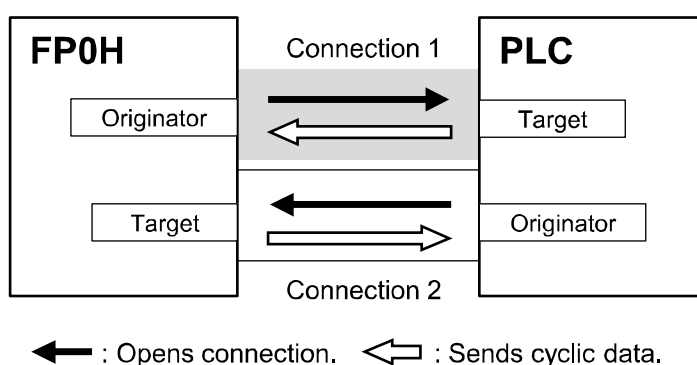

For the communication between the FP0H and other I/O devices, the FP0H is the originator. According to devices, the data transmissions by "Input Only" (from target to originator) and "Exclusive Owner" (two-way) may be available.

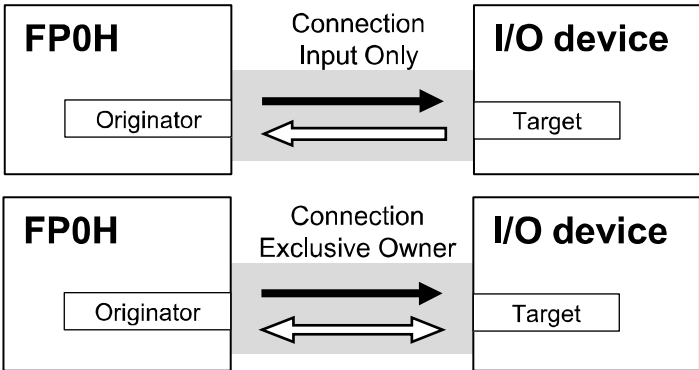

← : Opens connection. ← : Sends cyclic data.

1.2 Names and Functions of Parts

1.2.1 Control Unit

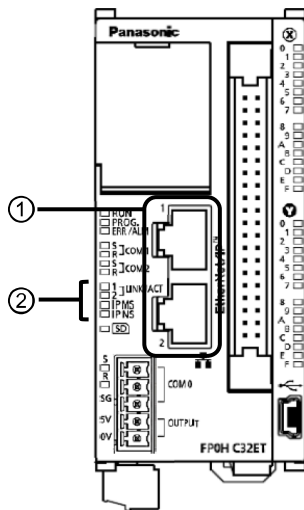

■ Names and Functions of Parts

Number	Name	Description
①	LAN port	<p>It is mounted to the FP0H Control Unit (Ethernet type). It is used for connecting to Ethernet and EtherNet/IP.</p> <p>The IP address and MAC address are common to the LAN ports 1 and 2. The wiring can be simplified by using the two ports.</p> <p>The MAC address is printed on the side face of the unit.</p>
②	Operation monitor LED	<p>IP MS: Displays the operating condition of the unit.</p> <p>IP NS: Displays the communication status of network.</p>

1.2.2 LED Displays When PLC Operates

The state of the PLC can be confirmed from the lighting state of the LEDs when the PLC is operating. The PLC states indicated by the LEDs are as follows.

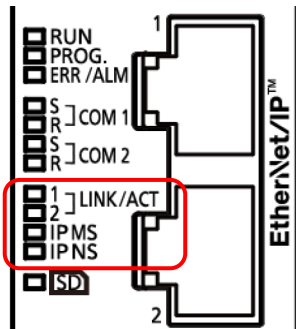

MS (Module status indicator) <Green/Red>

LED display	PLC state
LED OFF	The EtherNet/IP function is disabled.
Green ON	The EtherNet/IP function is normally activated.
Green Flashing	This state does not exist.
Red ON	Unrecoverable fault occurs.
Red Flashing	Recoverable fault occurs. (such as a setting that load factor exceeds)

NS (Network status indicator) <Green/Red>

LED display	PLC state
LED OFF	The EtherNet/IP function is disabled or IP address is not established.
Green ON	More than one connection is established.
Green Flashing	Connection is not established, but IP address is acquired.
Red ON	IP address duplication is detected.
Red Flashing	This state does not exist.

■ **LED displays when PLC is started**

The MS and NS LEDs turn on in the following order when the FP0H is started.

Each lighting time of the lighting order 1 to 4 is 0.25 seconds.

Lighting order	Lighting state	
	MS	NS
1	Green ON	OFF
2	Red ON	OFF
3	Green ON	Green ON
4	Green ON	Red ON
5	Green ON	OFF

1.3 Restrictions

■ Connecting to External Devices

LAN ports 1 and 2 have the same IP address and MAC address.

- Do not connect the cables from the two LAN ports to the same switching HUB.
- When performing daisy chain connection, do not connect devices in a ring shape.

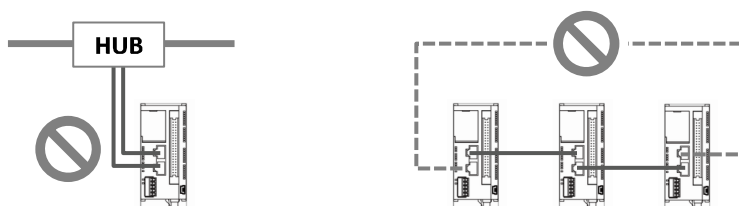

■ Number of connections

For the FP0H, the total number of connections of Ethernet communication and EtherNet/IP communication should be 9 or less. For the details of the setting of the number of connection, refer to “3.2.1 Ethernet Settings”.

(The no. of user connections of Ethernet communication) + (EtherNet/IP communication) ≤ 9 connections

■ Restrictions by FP0H specifications

Item	Specifications
RPI	1 to 10000 ms (In 0.5 ms unit)
Cyclic communication allowable communication band	5000 pps (Packet size: 2 to 510 bytes) 2500 pps (Packet size: 511 to 1450 bytes)
Usable devices	WX, WY, WR, WL, DT, LD
Device specification of each tag/instance	Max. 8 devices

2

Cyclic Communication

2.1 Cyclic Communication Function

2.1.1 Overview of Cyclic Communication

The cyclic communication is a function to perform data transmission with constant intervals (RPI) between PLC and PLC or PLC and I/O device on the EtherNet/IP network.

In the cyclic communication, one device opens a communication line which is called connection for a destination device. The side which opens the connection (communication line) is called "originator", and the side which the connection is opened is called "target".

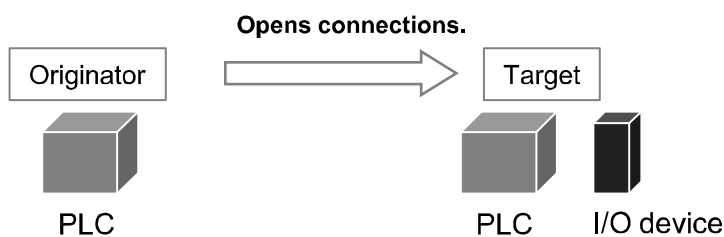

Connection information on the cyclic communication is set in the originator. The originator connects to the target according to the connection information. The tag/instance required for the connection from the originator is registered in the target.

Once the connection is open, the cyclic communication begins according to the settings of the connection information.

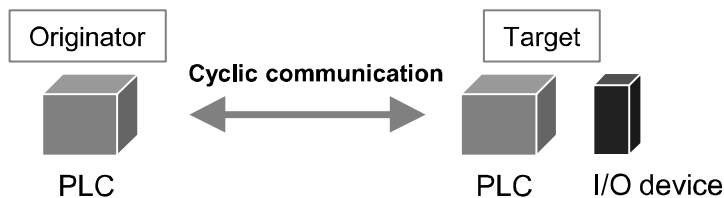

Comparison of originator and target

Item	Originator	Target
Applicable model	PLC	PLC, I/O device
When starting communication	Opens connections. (Connects to targets.)	Connection is opened. (Connected from originator.)
Connection information	Target connection information - IP address - Tag/Instance Cyclic communication information - RPI - Communication method, etc.	Connected from originator - Tag/Instance

2.1.2 Operation of Cyclic Communication

The communication behavior in the cyclic communication varies according to the settings of connections.

	Description
Input Only	Data is sent in the input direction only (From target to originator)
Exclusive Owner	Data is sent bi-directionally.

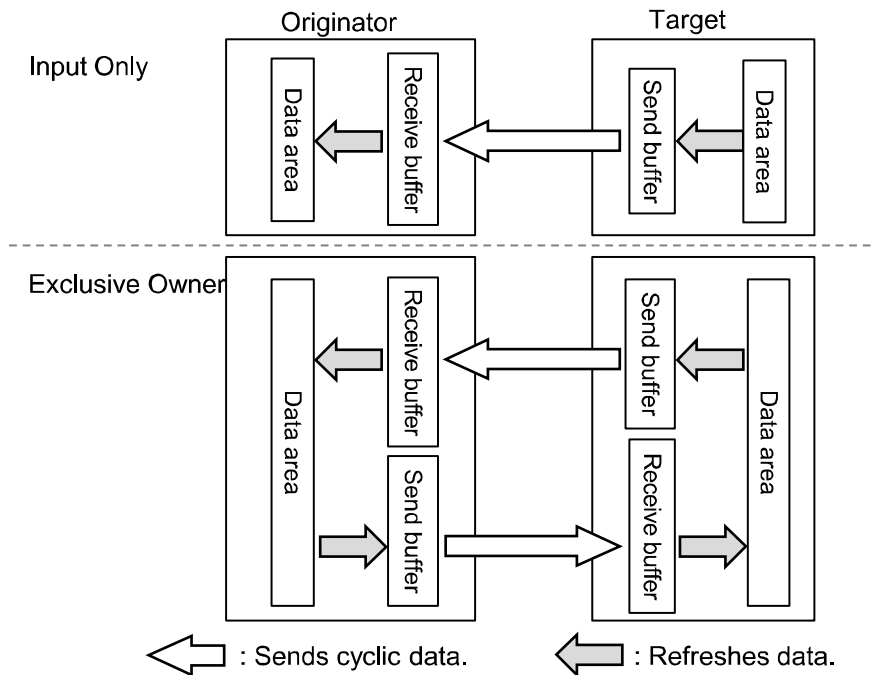

- For some target devices, "Exclusive Owner" setting is not available.
- When PLCs including FP0H are set as targets, "Input Only" setting is only available.
- For sending/receiving data between PLC and PLC, it is necessary to use two connections and open them each other.

The transfer operations from "Data area" to "Send buffer" and from "Receive buffer" to "Data area" in each device are called "Refresh".

2.1.3 Data Refresh of Cyclic Communication

In the cyclic communication, data is refreshed in synchronization with operation cycle and RPI. The refresh of sent data and received data is controlled for each RPI.

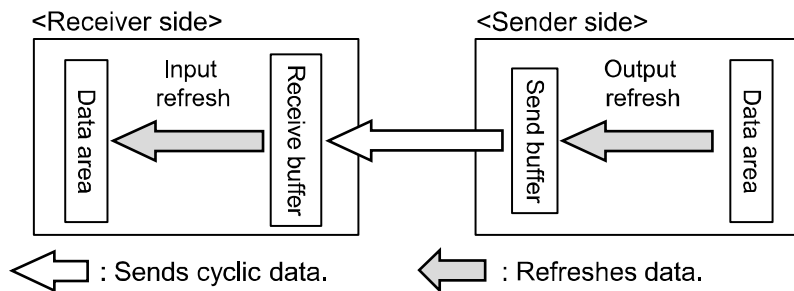

Refresh direction	Refresh operation
Input refresh	In refresh processing at the beginning of scan, if there is incoming data in the receive buffer for the cyclic communication, it is copied to the operation memory. After the completion of the refresh operation, the latest received data will be an object to be refreshed in the next time.
Output refresh	In refresh processing at the beginning of scan, if there is space in the send buffer for the cyclic communication, it is copied from the data area. If the refreshing has not been completed at the time of data transmission, the previous refreshed data is sent.

Refresh operation when starting communication

- After confirming that the connection is open with the connection open flag, refreshes sent data.
- After detecting received data with the received data existence flag, refreshes received data.
- After refreshing received data, the normal reception active flag turns ON.

2.1.4 Data Area Specifications Using Tag/Instance

In the cyclic communication, the data send and received areas are specified using "Tag" or "Instance".

- For "Tag", the areas are specified by symbols. For "Instance", they are specified by numbers.
- For some target devices, only either of "Tag" and "Instance" may be available.
- In the connection of "Exclusive Owner", the receive area of each target is specified by another tag or instance.

(Note) Even when specifying by tag, numbers are assigned to packets during the actual cyclic communication.

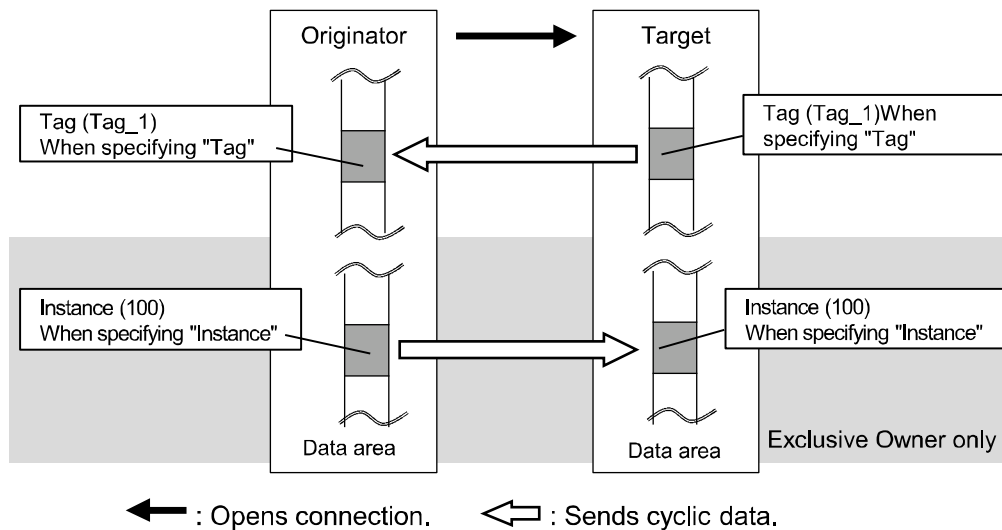

Settings of target and originator

	Settings
Originator	Tag/Instance of connected target Data area/size of originator corresponds to Tag/Instance
Target	Tag/Instance connected from originator Data area/size of target corresponds to Tag/Instance



◆ KEY POINTS

- In each connection, the sizes of the data areas which correspond to the originator and target should be the same.
- For the FP0H, the data areas of each connection can be allocated to the operation memories in a maximum of 8 areas. Device names that can be allocated are WX, WY, WR, WL, LD, and DT. For the automatic allocation, the WL and LD areas are used.

2.2 Cyclic Communication of FP0H

2.2.1 Connection using FP0H as originator

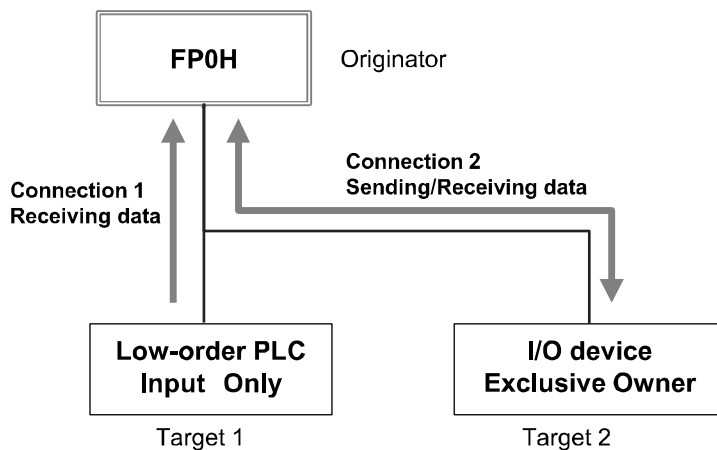

Register target low-order PLCs and I/O devices in "Scan List" of FP0H and register connection information. The registration is made for each target.

Register the following information in the connection information.

- Connected target information (IP address, Tag/Instance)
- Data area and size that corresponds to Tag/Instance
- Cyclic communication information (RPI, Communication method)

The FP0H establishes connections with targets registered in Scan List and performs the cyclic communication.

	Description
Input direction (Direction from Target to Originator)	Data is sent from targets to the FP0H periodically.
Output direction (Direction from Originator to Target)	Data is sent from the FP0H to targets periodically.



◆ KEY POINTS

- **Scan List is a list for setting the connection information with "Target". Use Programming software FPWIN GR7 for the registration.**
- **For registering other companies' EtherNet/IP devices in Scan List, the EDS files of those devices are required. Communication parameters that can be set in each device are defined in the EDS files.**

2.2.2 Connection Using FP0H as Target

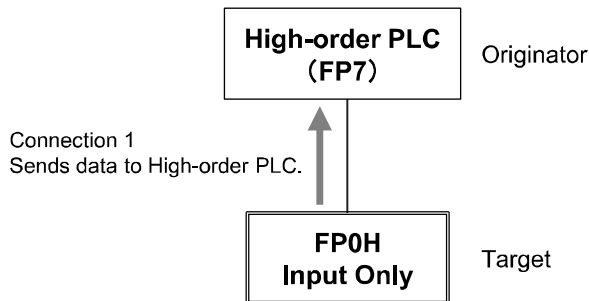

Register the tag/instance information in the "I/O map" of the FP0H.

- The tag/instance information is registered for each originator.
- The high-order PLC (FP7) (originator) makes a connection for the registered tag/instance.

The tag/instance information includes the following information.

- Connected tag/instance
- Data area and size that corresponds to Tag/Instance

When the FP0H is used as target, only the transmission to originator (Input Only) is available.

Once the connection from an originator is established, the FP0H sends data to the originator from the buffer for the cyclic communication periodically.



◆ KEY POINTS

- I/O map is a list for setting the connection information with "Originator". Use Programming software FPWIN GR7 for the registration.
- The EDS file of FP0H can be downloaded from our website. https://industrial.panasonic.com/ac/e/dl_center/software/
- For using the FP0H as a target, the both methods, tag and instance, are available. However, the selectable instance IDs for the instance method are 100 to 199.

2.2.3 Example of Configuration When FP0H is Originator and Target

Example of Configuration When FP0H is Originator and Target

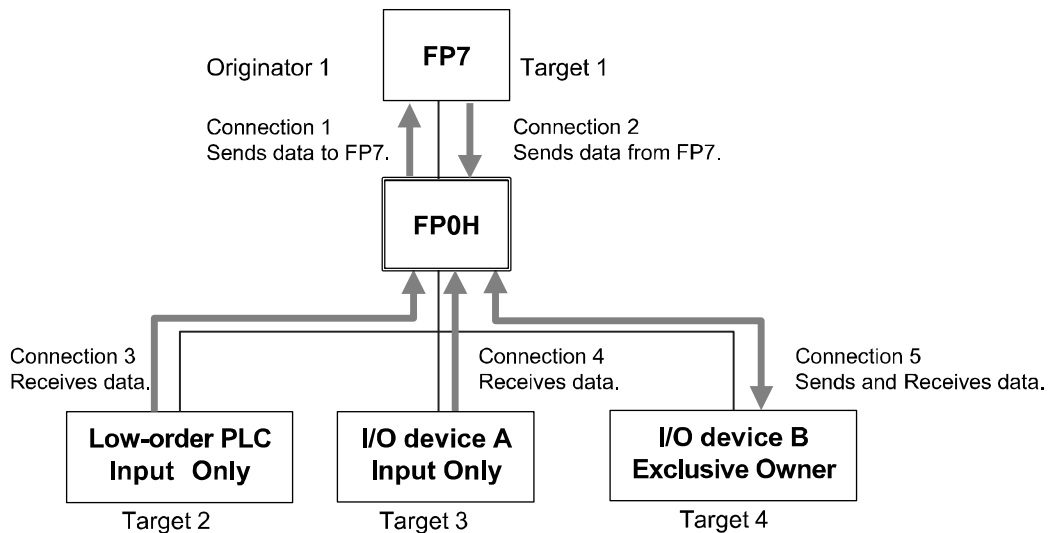

In the example, the FP0H uses five connections.

Set the FP0H as below to send/receive data with the high-order FP7.

- Register the FP7 in the scan list and set the connection information.
- Register the I/O map for connecting the FP7 and set the tag/instance information.

Set the FP0H as below to receive data from low-order devices (low-order PLC, I/O devices A and B). When the connection with a target is "Exclusive Owner", data can be sent and received.

- Register the low-order PLC, I/O devices A and B in the scan list and set the connection information.

3

Setting Procedure

3.1 Overview of Settings

3.1.1 System Example

This chapter describes the case of setting FP0H(A) in the following system example.

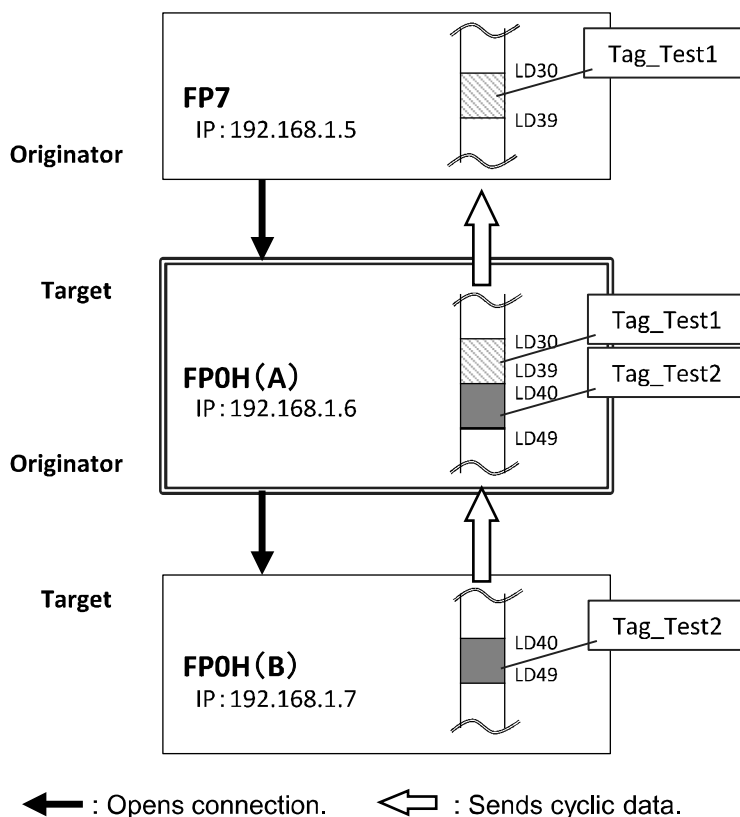

Operation of FP0H(A)

- The data received from the Tag (Tag_Test2) of the FP0H(B) is stored in the data area (LD40 to 49) of the FP0H(A). The FP0H(A) is the originator for the FP0H(B).
→ Add the FP0H(B) in the scan list and make the connection setting.
- The data stored in the data area (LD30 to 39) of the FP0H(A) is sent to the FP7. The FP0H(A) is the target for the FP7.
→ Add the tag (Tag_Test1) in the I/O map and register the data area.
- The number of used connections totals two.

3.1.2 Setting Procedure

The setting procedure is as follows.

Use Programming software Control FPWIN GR7 (hereinafter referred to FPWIN GR7) for the settings.

	Item	Outline of operation	Reference
1	Initial setting of Ethernet /IP	Enable EtherNet/IP communication in the "Ethernet settings" and make the initial setting of EtherNet/IP.	p.3-4
2	Settings of connection using FPOH as originator	Register EDS Files of target devices.	p.3-9
		Add targets in the scan list.	p.3-10
		Register connection information (such as connected targets, cyclic communication, corresponding data areas and sizes).	p.3-11
3	Settings of connection using FPOH as target	Add I/O map in the scan list.	p.3-17
		Register the tag/instance information connected.	p.3-18
4	Confirmation of load factor calculation	Confirm the load factor calculation is 100% or less.	p.3-21
5	Saving of Ethernet/IP settings	Save the settings of EtherNet/IP.	p.3-22

3.2 Initial Setting of Ethernet /IP

3.2.1 Ethernet Settings

This is the setting for the communication function via LAN ports including EtherNet/IP. Use FPWIN GR7 for the setting. The following procedure is explained on the condition that FPWIN GR7 has already started.



◆ PROCEDURE

1. Select "Option" > "Ethernet settings" from the menu bar.

The "Ethernet settings" dialog box appears.

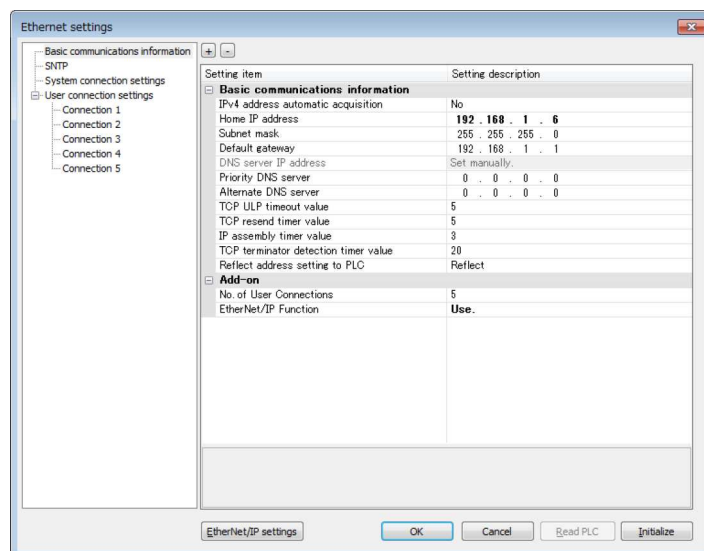

2. As necessary, change "Home IP address" and "No. of User Connections".
In this example, "IP address = 192.168.1.6", and "No. of User Connections = 5".
3. Change the setting of "EtherNet/IP Function" to "Use".
4. Press the [OK] button.



◆ KEY POINTS

- The number of connections available for EtherNet/IP is (9-"No. of user connection"). When the value is "5" which is initial value, the number of connections available for EtherNet/IP is "4".



◆ NOTES

- If the setting of "EtherNet/IP Function" is changed to "Not use", the EtherNet/IP setting information will be cleared.

3.2.2 Starting EtherNet/IP Setting Screen

The following procedure is explained on the condition that FPWIN GR7 has already started.



◆ PROCEDURE

1. Select "Option" > "EtherNet/IP Settings" from the menu bar.

The EtherNet/IP setting screen appears.

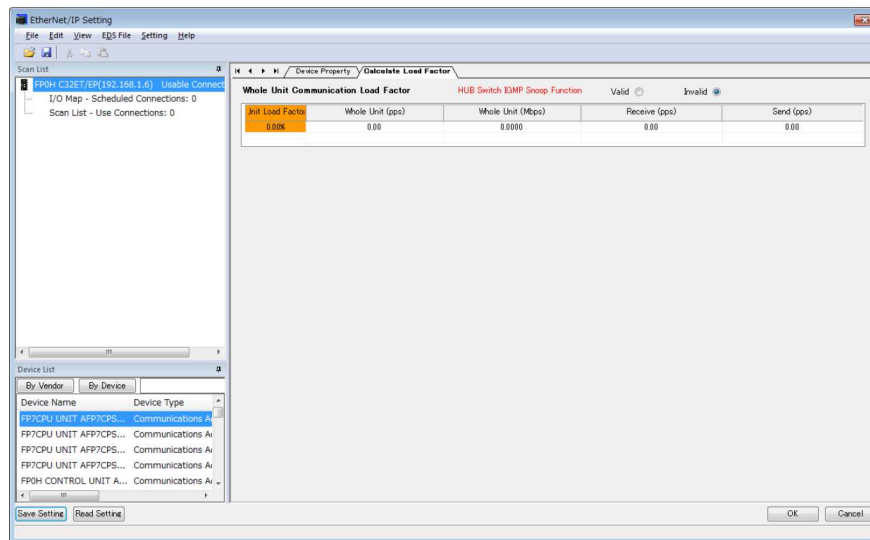

The following description assumes that the EtherNet/IP setting screen has been activated.

3.2.3 EtherNet/IP Basic Configuration

Make the EtherNet/IP basic configuration. The following procedure is explained on the assumption that the EtherNet/IP setting screen has been activated.



◆ PROCEDURE

1. Select "Setting" > "EtherNet/IP Basic Configuration" from the menu bar.

The EtherNet/IP Basic Configuration dialog box appears.

2. Change the settings of "Auto Allocation" and "RUN/IDLE bit operation of cyclic communication" as necessary.

In this example, "Auto Allocation = No", and "RUN/IDLE bit operation of cyclic communication = Normal".

3. Press the [OK] button.



◆ KEY POINTS

- When allocating devices manually, set "Auto Allocation" to "No".
- For performing operation check, set "RUN/IDLE bit operation of cyclic communication" to "Limited". When selecting "Normal", the RUN/IDLE bit of the FP0H does not turn "ON" unless the communications with all the targets registered in the scan list are established.

3.2.4 Items of Ethernet /IP Basic Configuration

■ Settings relating to cyclic communication operation

Item	Default	Description
Auto Allocation	Yes	Set whether to use the automatic allocation of devices or not (Yes/No). Auto Allocation "Yes": Devices for the I/O map setting and connection setting are automatically allocated. Auto Allocation "No": Devices are allocated manually.
LD Device Starting No.	0	Set the starting device number to be allocated at the time of the device automatic allocation. Default: 0 (Allocated from LD0 in sequence.)
RUN/IDLE bit operation of cyclic communication	Normal	Set the operating condition of the RUN/IDLE bit (Normal/Limited). "Normal": Turns on when the FP0H is in RUN mode and normally communicating with all the targets (except FP0H) registered in the scan list. "Limited": Turns on when the FP0H is in RUN mode.

■ Settings relating to abnormality judgement

Item	Default	Description
Cyclic Communication Node Connection Wait Time	60 s	Set the period of time during which retry is repeated without error determination.

■ Settings relating to Multicast

Item	Default	Description
TTL for Multicast	1	Specify the number of routers that multicast transmission packets can pass.
Multicast Address Setting Method	Auto	Set "Auto" or "Specify".
No. of Multicast Addresses	(256)	Set the number of multicast addresses. This item is valid when Multicast Address Setting Method is specified.
Multicast Starting IP Address	(239.255.0.0)	Set the starting IP address of multicast. This item is valid when Multicast Address Setting Method is specified.

(Operation of Auto Allocation)

Devices are allocated using the value specified for "LD Device Starting No." in "EtherNet/IP Basic Configuration" as the starting device.

- Allocating order

I/O map no. 1
I/O map no. 2
:
Node 1 of scan list (Input to Output)
Node 2 of scan list (Input to Output)
:
:

Devices are automatically reallocated when either the scan list or I/O map is added (deleted) and the allocated data size is changed.

3.3 Settings of Connection Using FP0H as Originator

3.3.1 Settings

This section describes the setting method of the connection using the FP0H as originator.

The FP0H(A) in the figure below is an object for the setting.

Ten word data is sent from the data area (LD40 to 49) of the FP0H(B) to the data area (LD40 to 49) of the FP0H(A).

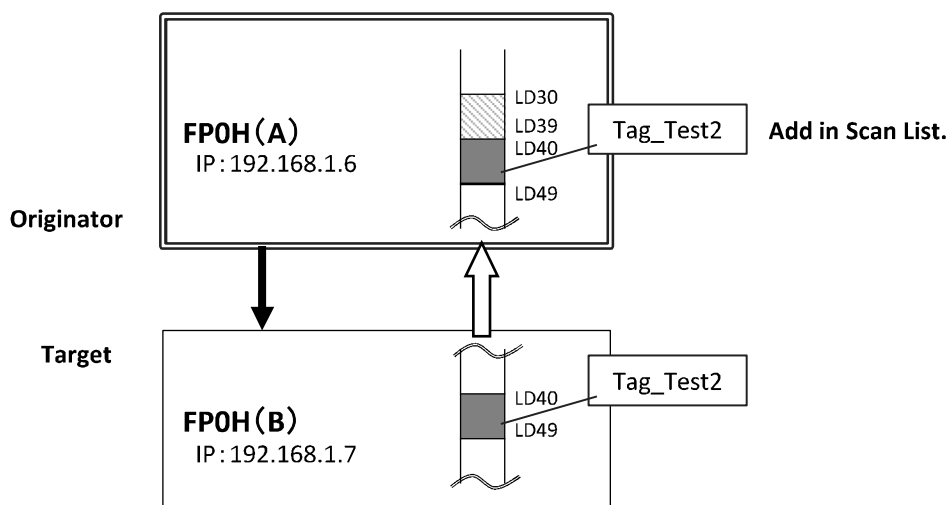

- Add the FP0H(B) to the scan list of the FP0H(A).
- Set the data area of FP0H(B) by specifying the tag (Tag_Test2).
- Set the data area of the own unit for the tag (Tag_Test2).

3.3.2 Registering EDS File of Target Device

When using other companies' devices as targets, their EDS files should be registered in the EtherNet/IP setting tool. Please acquire EDS files from each vendor's website.

Register EDS Files of target devices in "Device List".

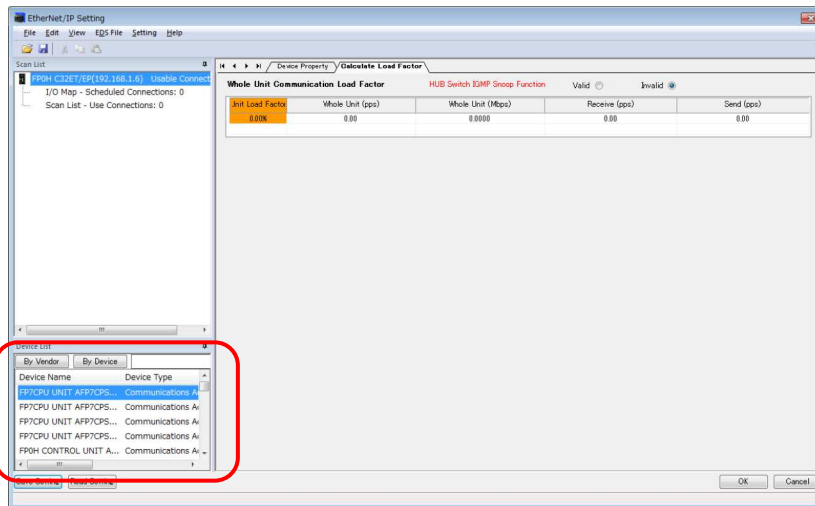

The following procedure is explained on the assumption that the EtherNet/IP setting screen has been activated.



◆ PROCEDURE

1. Select "EDS File" > "Register" from the menu bar.
2. Select an EDS file to be registered from the explorer screen and press "Open".

The used target device will be added to "Device List". Once the EDS file is registered, the registration is not required from the next time.

3.3.3 Adding Target in Scan List

Add connected targets in the scan list. The following procedure is explained on the assumption that the EtherNet/IP setting screen has been activated.



◆ PROCEDURE

1. Select and right-click a registered target device (in this example, FP0H CONTROL UNIT...) from Device List.

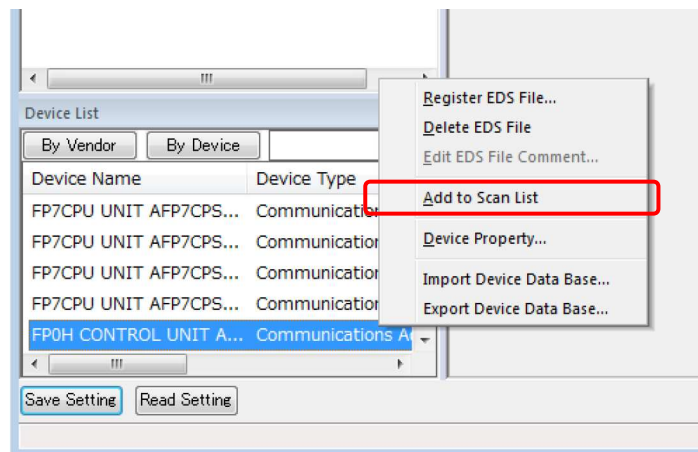

2. Select "Add to Scan List" from the displayed menu.

The target will be added.

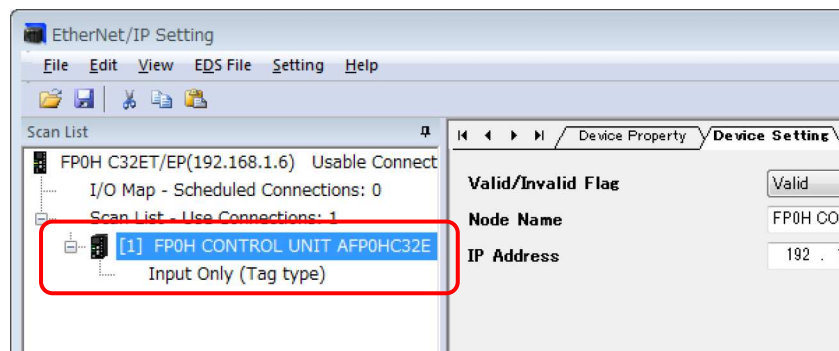

(Reference) The display content of the target added to Scan List

[1] FP0H CONTROL UNIT AFP0HC32E
Input Only (Tag type)

Node no.	1
Node Name	FP0H CONTROL UNIT AFP0HC32E
Connection Name	Input Only (Tag type)

3.3.4 Setting IP Address of Target

Set the IP address of the target added to Scan List. The following procedure is explained on the assumption that the EtherNet/IP setting screen has been activated.



◆ PROCEDURE

1. Select the node name of the target from Scan List.

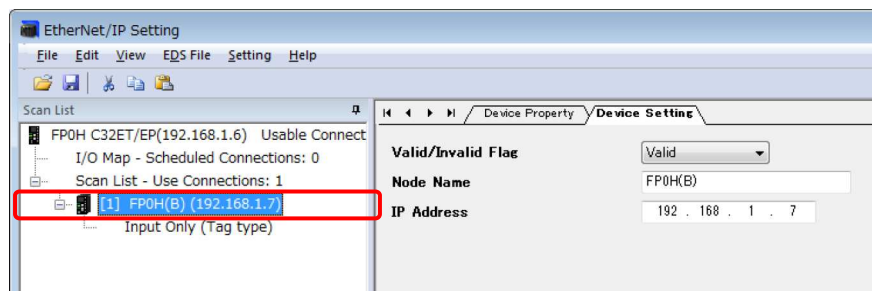

The "Device Setting" screen appears.

2. Set the "IP Address" of the target.

In this example, "IP address = 192.168.1.7".

3. Specify a node name as necessary.

In this example, "Node Name = FP0H(B)".



◆ KEY POINTS

- Unchanging the node name does not affect the cyclic communication. The change is reflected in Scan List. It helps to distinguish the targets of the same device.
- When setting "Valid/Invalid Flag" to "Invalid", the reservation node setting is enabled.

3.3.5 Setting Tag/Instance

Set the communication method (Tag/Instance) corresponding to the target added to Scan List. The following procedure is explained on the assumption that the EtherNet/IP setting screen has been activated.



◆ PROCEDURE

1. Select the connection name from Scan List.

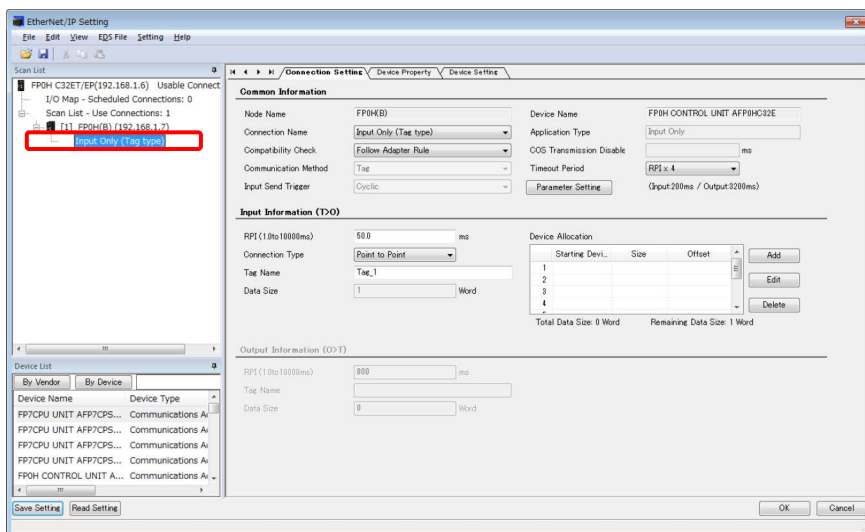

The "Connection Setting" screen appears.

2. Select a communication method (Tag or Instance) in "Connection Name".

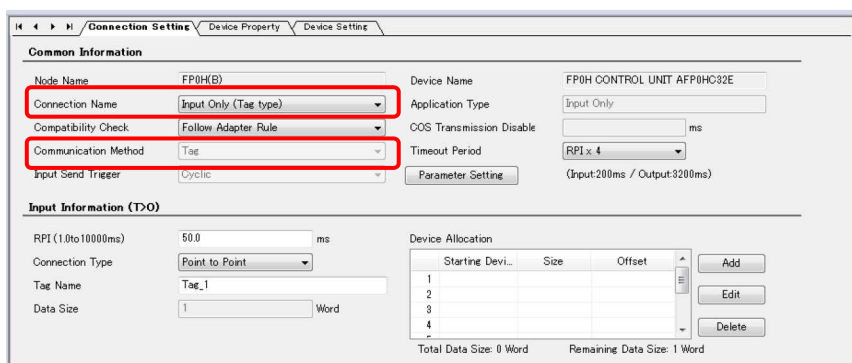

Once "Connection Name" is selected, "Communication Method" (Tag/Instance) will change.

In this example, "Connection Name = Input Only (Tag type)".

3. According to the target, change "Tag Name/Instance Name" and "Data Size".

The screenshot shows the 'Connection Setting' dialog box. In the 'Common Information' section, 'Node Name' is 'FP0H(B)', 'Device Name' is 'FP0H CONTROL UNIT AFP0HC32E', and 'Application Type' is 'Input Only (Tag type)'. In the 'Input Information (T>O)' section, 'Tag Name' is 'Tag_Test2' and 'Data Size' is '10 Word'. A 'Parameter Setting' button is highlighted with a red box.

(Note) The Instance ID and data size are changed from "Parameter Setting".

The screenshot shows the 'Parameter Setting' dialog box. In the 'Input Information (T>O)' section, 'Data Size' is '20 Byte' and 'Instance ID' is '0'. In the 'Output Information (O>T)' section, 'Data Size' is '0 Byte' and 'Instance ID' is '0'. The 'Configuration data' section is empty.

In this example, "Tag Name = Tag_Test2", and "Data Size = 20 bytes (10 words)".



◆ KEY POINTS

- For some targets, "Application Type" (Input Only/Exclusive Owner) can be selected from "Connection Name".
- When "Exclusive Owner" is selected for "Application Type", specify "Output Information (O>T)" for sending data from the originator to the target.
- Items such as "RPI" and "Input Send Trigger" can be changed in the "Connection Setting" screen.
(Refer to "4.3.2 Operations in Connection Setting Screen".)

3.3.6 Specifying Data Area Corresponding to Tag/Instance

For setting the data area manually, change the auto allocation to "No" in the "EtherNet/IP Basic Configuration". When it is set to "Yes", this procedure is not required.

The following procedure is explained on the assumption that the EtherNet/IP setting screen has been activated.



◆ PROCEDURE

1. Select the connection name whose setting is made from Scan List.

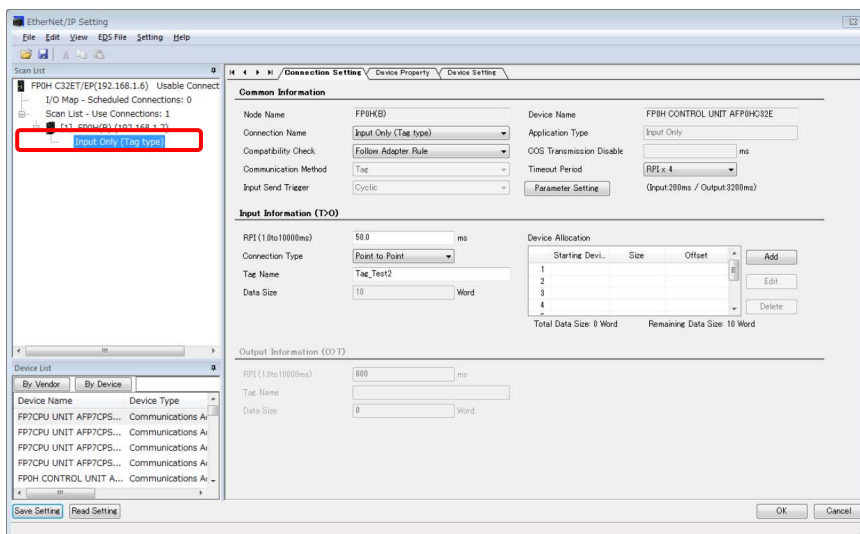

The "Connection Setting" screen appears.

2. Press "Add" in the Device Allocation area.

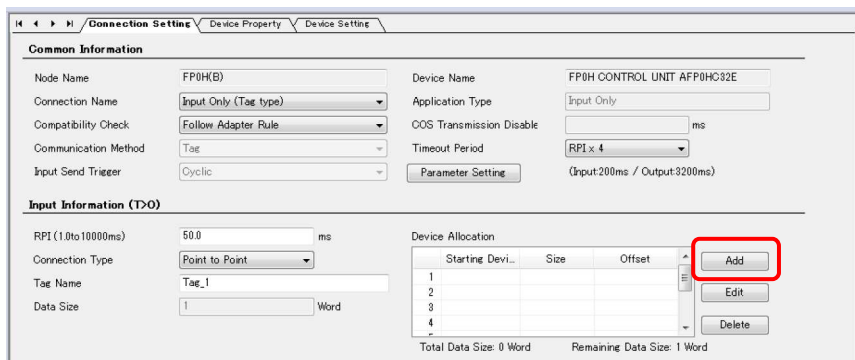

3. Specify "Device Type", "Device No." and "Data Size", and press "Register".

3.3 Settings of Connection Using FP0H as Originator

In this example, "Device Type = LD", "Device No. = 40" and "Data Size = 10".



NOTES

- When "Exclusive Owner" is selected for "Application Type", specify "Output Information (O>T)" for sending data from the originator to the target.

3.3.7 Reference: Setting of Target [FP0H(B)]

For the target FP0H(B), add the I/O map and set as follows.

Item	Settings
IP Address	192.168.1.7
Communication method	Tag
Tag Name	Tag_Test2
Data Size	10 words

3.4 Settings of Connection Using FP0H as Target

3.4.1 Settings

This section describes the setting method of the connection using the FP0H as target. The FP0H(A) in the figure below is an object for the setting.

Ten word data is sent from the data area (LD30 to 39) of the FP0H(A) to the data area (LD30 to 39) of FP7.

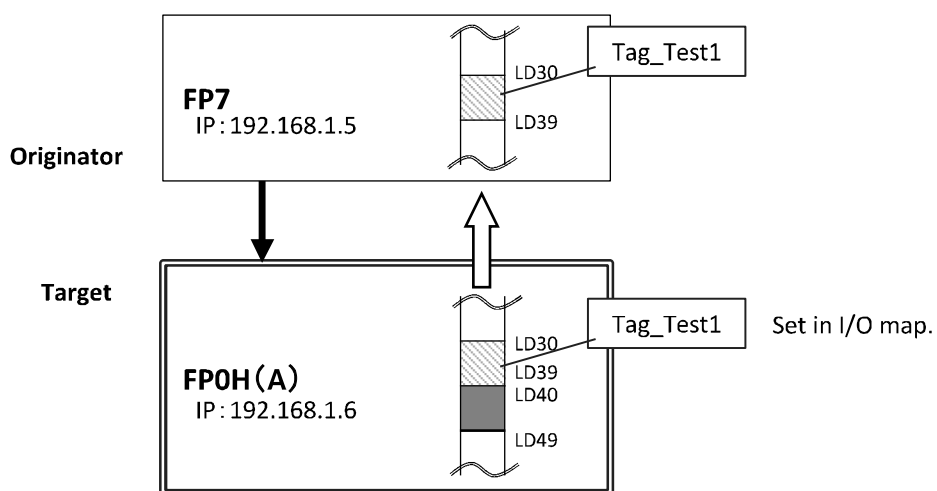

- When the FP0H is used as target, only the data transmission to originator is available.
- Register a tag (Tag_Test1) specified from the FP7 (Originator) in the "I/O map".
- Set the data area (LD30 to 39) corresponding to the tag.

3.4.2 Adding I/O Map to Scan List

Add the I/O map in Scan List. The following procedure is explained on the assumption that the EtherNet/IP setting screen has been activated.



◆ PROCEDURE

1. Select and right-click "I/O Map - Scheduled Connections: 0" from Scan List.

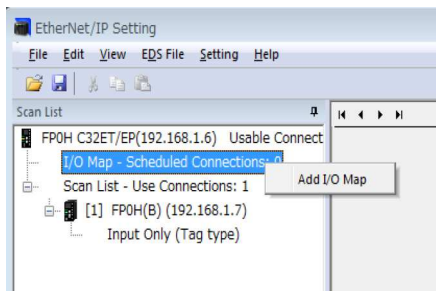

2. Select "Add I/O Map" from the displayed menu.

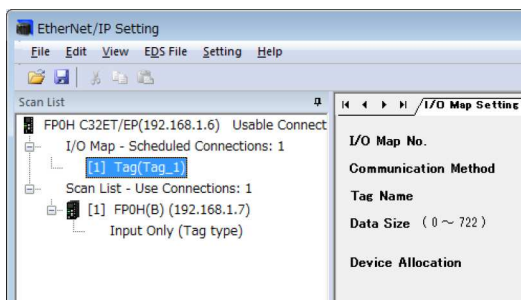

The I/O map will be added to Scan List.

(Reference) The display content of the I/O map added to Scan List

[1] Tag(Tag_1)

I/O map No.	1
Communication method	Tag
Tag Name/Instance ID	Tag_1

3.4.3 Registering Tag Name/Instance ID

Register the Tag Name/Instance ID specified from originator. The following procedure is explained on the assumption that the EtherNet/IP setting screen has been activated.



◆ PROCEDURE

1. Select the target I/O map from Scan List.

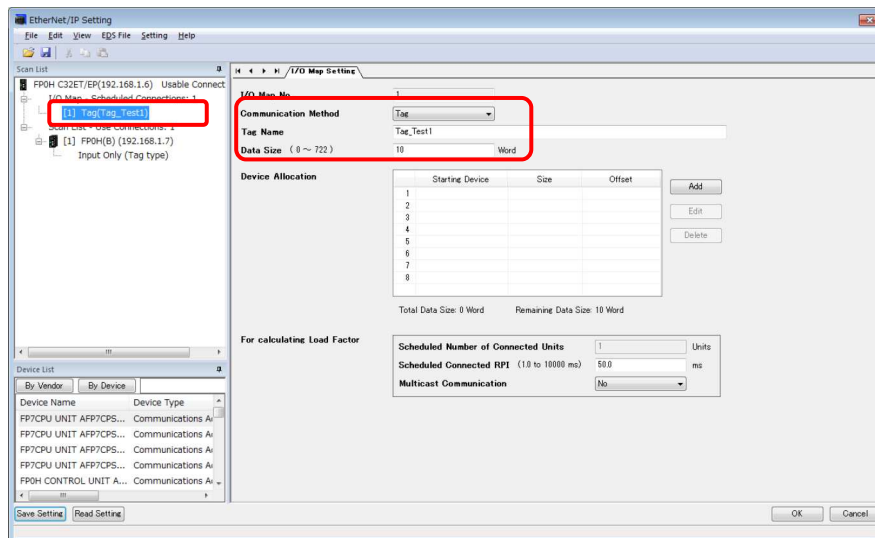

"I/O Map Setting" screen appears.

2. Select Communication Method (Tag or Instance).

In this example, "Communication Method = Tag".

3. Input Tag Name/Instance ID.

In this example, "Tag Name = Tag_Test1".

4. Input "Data Size" of transmission data.

In this example, "Data Size = 10 words".



◆ KEY POINTS

- Register Tag/Instance for each connected originator.
- When connected from more the one originators, the connections are distinguished by each instance ID/tag name.

3.4.4 Registering Data Area Corresponding to Tag/Instance

For setting the data area manually, change the auto allocation to "No" in the "EtherNet/IP Basic Configuration". When it is set to "Yes", this procedure is not required.

The following procedure is explained on the assumption that the EtherNet/IP setting screen has been activated.



◆ PROCEDURE

1. Select the target I/O map from Scan List.

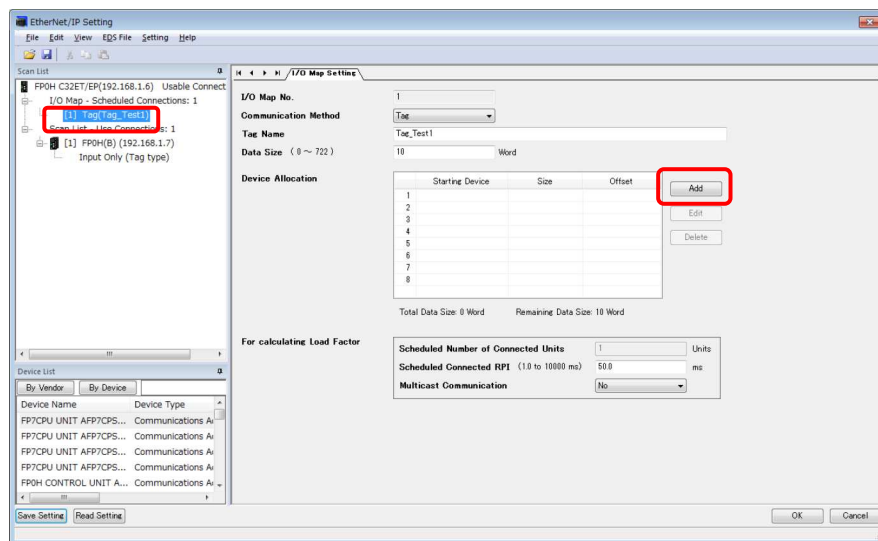

"I/O Map Setting" screen appears.

2. Press "Add" in the Device Allocation area.
3. Specify "Device Type", "Device No." and "Data Size", and press "Register".

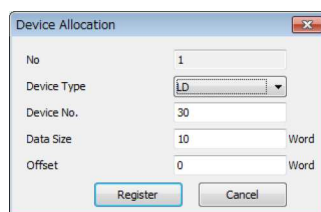

In this example, "Device Type = LD", "Device No. = 30" and "Data Size = 10".



◆ KEY POINTS

- Register Tag/Instance for each connected originator.
- When connected from more the one originators, the connections are distinguished by each instance ID/tag name.

3.4.5 Reference: Setting of Originator [FP7]

For the originator FP7, add the FP0H in Scan List and set as follows.

Item	Settings
Target IP Address	192.168.1.6
Connection Name	Input Only (Tag type)
Tag Name	Tag_Test1
Data Size	10 words

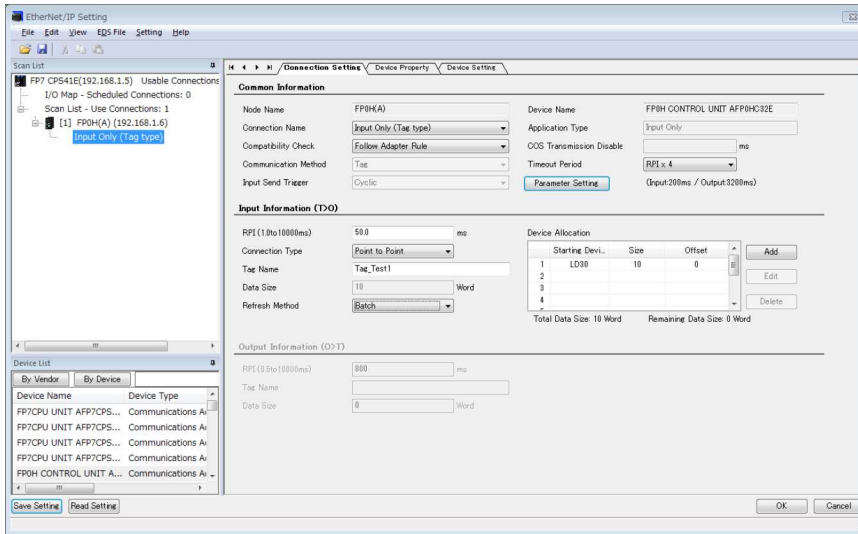

3.5 Confirmation of Load Factor Calculation

3.5.1 Load Factor Calculation

The load factor is the calculated ratio of the number of actually used packets to the maximum number of packets which the FP0H can send/receive in one second by cyclic communication.

- Packets other than by cyclic communication or unnecessary received packets are not considered for calculating the load factor.
- Reserved nodes are not included in the calculation of load factor.

3.5.2 Displaying Load Factor Calculation

The following procedure is explained on the assumption that the EtherNet/IP setting screen has been activated.



◆ PROCEDURE

1. Select the uppermost "FP0H C32ET/EP(192.168.1.6) Usable Connect..." from Scan List.

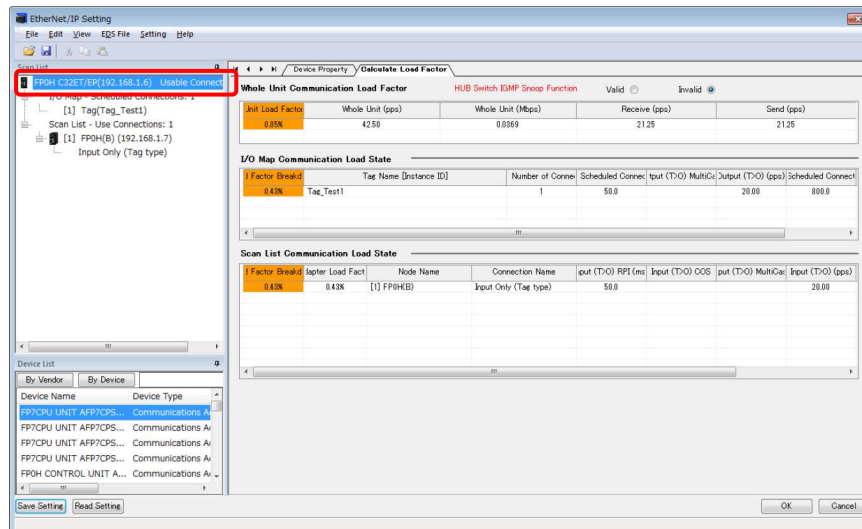

The "Calculate Load Factor" window appears.

2. Confirm each load factor of the whole unit, I/O map and scan list.
Load factors for each setting of I/O map and scan list are calculated separately.



◆ NOTES

- The load factors of FP0H and each target should be 100% or less.

3.6 Saving EtherNet/IP Settings

3.6.1 Saving EtherNet/IP Settings in Project

The following procedure is explained on the assumption that the EtherNet/IP setting screen has been activated.



PROCEDURE

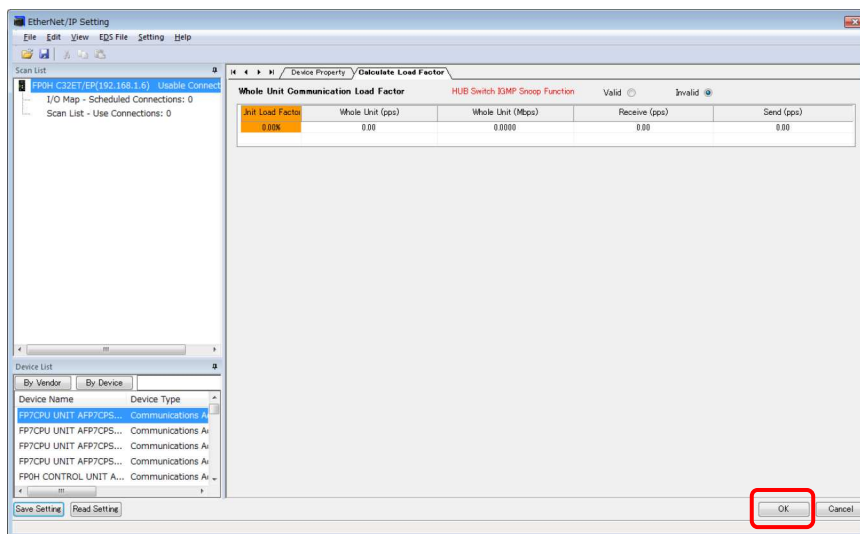

Press the [OK] button on the lower right of the screen.

3.6.2 Saving/Reading EtherNet/IP Settings in File

Save and read the settings specified in the EtherNet/IP Setting screen into a separate file from the project file. The saved EtherNet/IP settings can be reused in multiple units and projects.

The following procedure is explained on the assumption that the EtherNet/IP setting screen has been activated.



◆ PROCEDURE

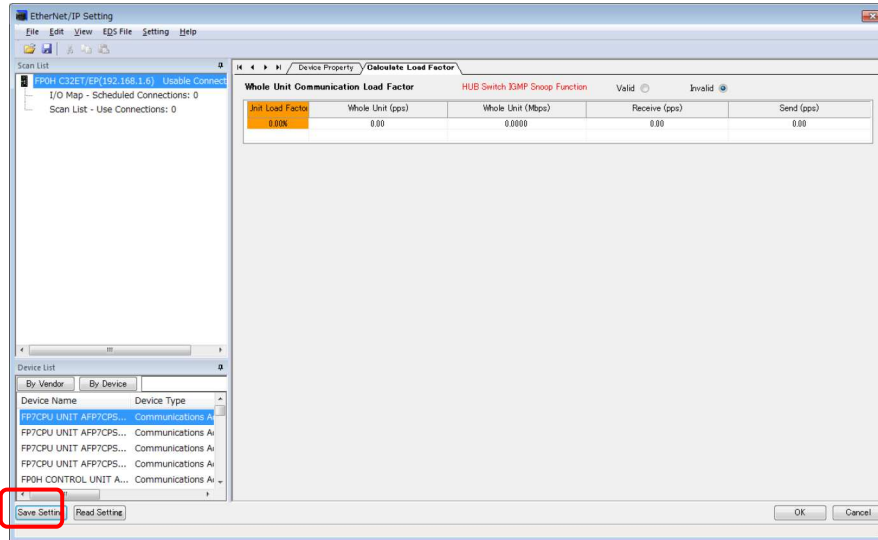

1. Press **[Save Settings]** on the lower left of the EtherNet/IP Setting screen.
The saving destination and file names appear.
(The same operation is performed when selecting "File" from the menu bar.)
2. Enter a saving destination and file name, and press **[Save]** button.
The settings specified in the EtherNet/IP Setting screen will be saved as a file whose extension is ".fp0heip".



◆ NOTES

- Closing the window with the "X" mark or **[Cancel]** on the lower right of the window cancels and stops the operation.

3.6.3 Writing EtherNet/IP Settings to FP0H

Transfer the settings specified in the EtherNet/IP Setting screen to the FP0H.

The following procedure is explained on the condition that FPWIN GR7 has already started.



◆ PROCEDURE

1. Select "Online" > "Download To PLC" from the FPWIN GR7 menu bar.
The EtherNet/IP settings will also be downloaded to the control unit along with information on programs, comments and system registers.

4

Tool Operation

4.1 Scan List Window

4.1.1 Display Contents of Scan List Window

The information displayed in Scan List is as follows.

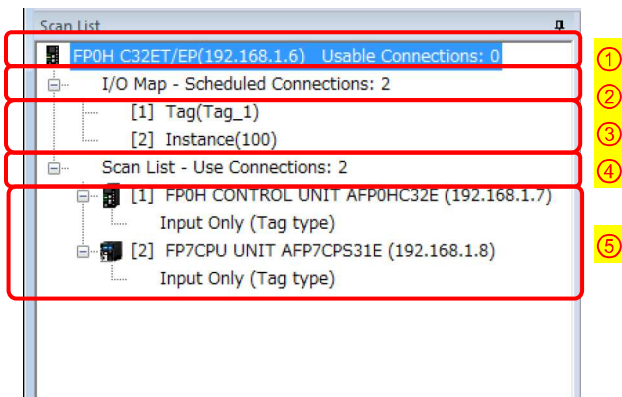

	Item	Description	Window display when selected	
①	Own unit	Shows the product name, (IP address) and the number of usable connections. No. of usable connection = "No. of connections allocated to Ethernet/IP" - "No. of set connection".	The "Calculate Load Factor" window appears. (Refer to p. 4-15.)	
②	No. of I/O maps	No. of tags/instances registered in I/O map This number should be same as the number of originators to be connected to the FP0H.	—	
③	Each I/O map	Tags/instances registered in I/O map	"I/O Map Setting" screen appears. (Refer to p. 4-14.)	
		For Tag		Shows the registered number and Tag (tag name).
	For Instance	Shows the registered number and Instance (instance ID).		
④	No. of nodes	No. of connections registered in Scan List Shows the number of targets to be connected to the FP0H.	—	
⑤	Each connection	Targets and connections registered in Scan List The display contents are as follows.	—	
		Upper line	Shows a node number and node name.	The "Device Setting" screen appears. (Refer to p. 4-9.)
		Lower line	Shows a connection name.	The "Connection Setting" screen appears. (Refer to p. 4-10.)

4.1.2 Operations in Scan List Window

Scan List can be edited by selecting and right-clicking an item in Scan List. Available operations vary according to the selected item.

When selecting the home unit

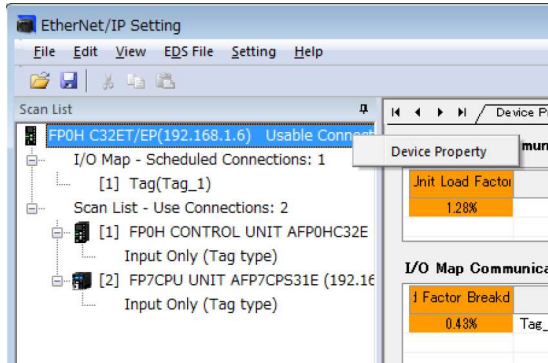

Display item	Description
Device Property	Shows the device property of the home unit.

When selecting the number of I/O maps

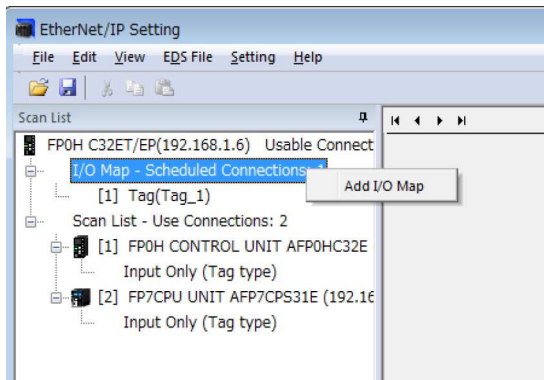

Display item	Description
Add I/O Map	Add an I/O map.

When selecting each I/O map

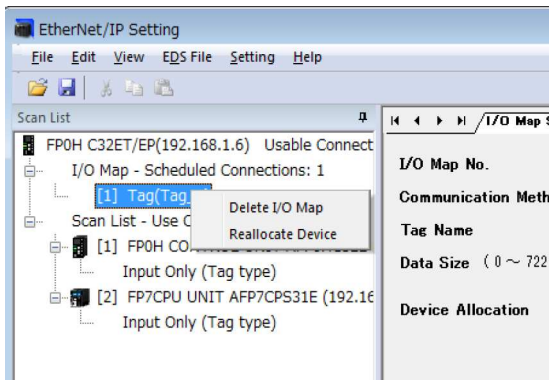

Display item	Description
Delete I/O Map	The selected I/O map is deleted from Scan List.
Reallocate Device	Devices are reallocated from the selected I/O map downward. (The target is I/O map only.) By specifying the LD device starting number, devices are automatically reallocated.

When selecting the number of nodes

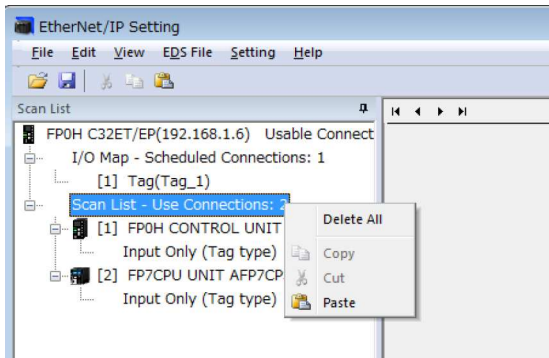

Display item	Description
Delete All	All nodes added to Scan List are deleted.
Paste	The copied node is pasted at the end of Scan List.

When selecting each node

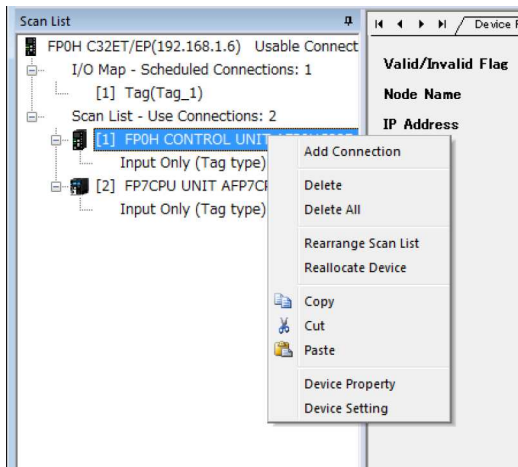

Display item	Description
Add Connection	Connections are added to the selected node. Depending on target devices, more than one connection can be established for one node.
Delete	The selected node is deleted from Scan List.
Delete All	All nodes added to Scan List are deleted.
Rearrange Scan List	Scan list is rearranged from the selected node downward. By specifying the starting number of node number and IP address, it is rearranged.
Reallocate Device	For only Scan List, devices are reallocated from the selected node downward By specifying the LD device starting number, devices are automatically reallocated.
Copy	The selected node is copied.
Cut	The selected node is cut.
Paste	The copied node is pasted after the selected node.
Device Property	The device property of the selected node is displayed.
Device Setting	The device setting of the selected node is displayed.

When selecting each connection

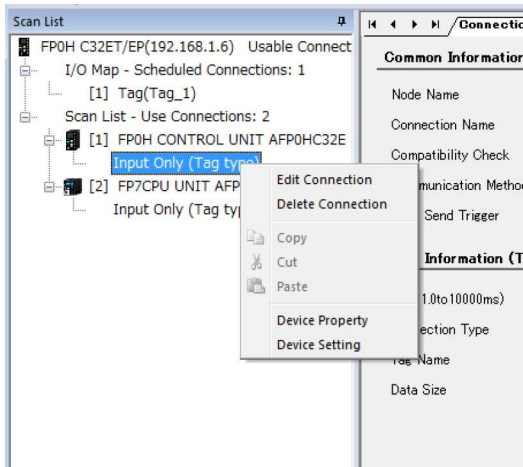

Display item	Description
Edit Connection	The connection setting of the selected connection is displayed.
Delete Connection	When there are more than two connection for one node, the selected connection is deleted.
Device Property	The device property of the selected connection is displayed.
Device Setting	The device setting of the selected connection is displayed.

4.2 Device List Window

4.2.1 Display Contents of Device List Window

The display contents of the Device List window are as follows.

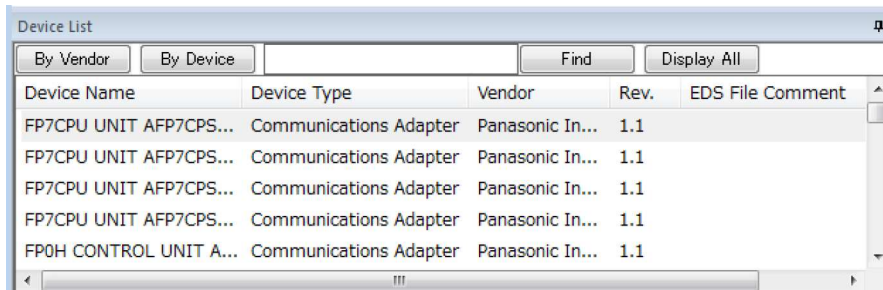

Display item	Description
By Vendor	Sorts registered EDS files by vendor.
By Device	Sorts registered EDS files by device type.
Find button	Displays only the EDS files found by pressing the button after entering a retrieval word.
Display All	Clears retrieval results and displays all registered EDS files.
List of registered devices	All devices whose EDS files have been registered are displayed in the EtherNet/IP Setting screen.

4.2.2 Operations from EDS File Menu

Select and right-click the device name to be operated from Device List.

(Or select "EDS File" from the menu bar.)

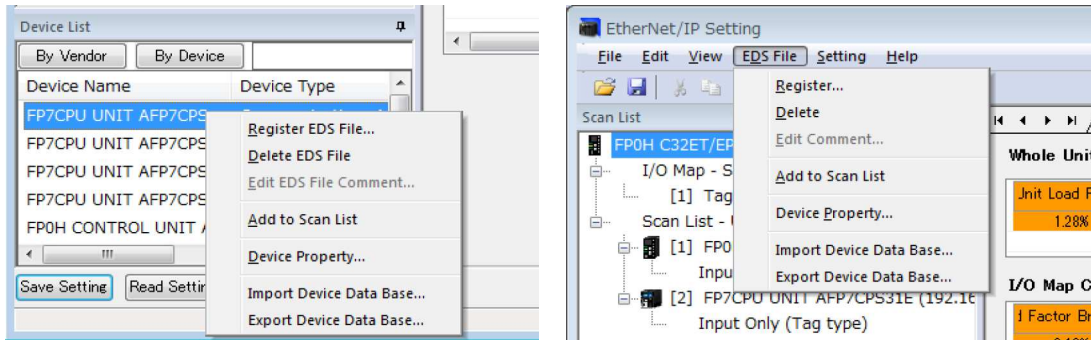

Display item	Description
Register EDS File	A new EDS file is registered in Device List.
Delete EDS File	The EDS file of the selected device is deleted.
Edit EDS File Comment...	A comment can be added to the EDS file of the selected device.
Add to Scan List	The selected device is added to Scan List.
Device Property	The "Device Property Information" defined in the EDS file of the selected device can be confirmed.
Import Device Data Base...	The device database (EDS file list information registered in Device List) can be imported. (Note) Always save the EtherNet/IP setting before the import operation. Because the EtherNet/IP setting is terminated after the import operation, the information in the middle of change operation will be cleared. Specify the folder in which the device database to be imported is stored. After the completion of the import, the EtherNet/IP Setting screen is automatically terminated. Restart the EtherNet/IP Setting.
Export Device Data Base...	The device database (EDS file list information registered in Device List) can be exported (stored). Select an storage folder for the device data base from the explorer. As registered EDS files, icon files, device database files are output to the selected folder, specify an empty folder for the storage destination.

4.3 Various Setting Screens

4.3.1 Operations in Device Setting Screen

The operations of "Device Setting" are as follows.

The screenshot shows a software interface with two tabs: "Device Property" and "Device Setting". The "Device Setting" tab is active. It contains three configuration fields:

- Valid/Invalid Flag:** A dropdown menu currently set to "Valid".
- Node Name:** A text input field containing "FP0H CONTROL UNIT AFP0HC32".
- IP Address:** A text input field containing "192 . 168 . 1 . 6".

Item	Default	Description
Valid/Invalid Flag	Valid	Set whether to make the communication with nodes valid or invalid. When set to Invalid, the device is set as a reserved device and exempt from the communication.
Node Name	Product name registered in the EDS file	Specify the node name of the device. The specified node name is displayed in Scan List.
IP Address	Automatically acquired when adding the target in Scan List	Set the IP address of the target. It can be set arbitrarily.

4.3.2 Operations in Connection Setting Screen

The operations of "Connection Setting" are as follows.

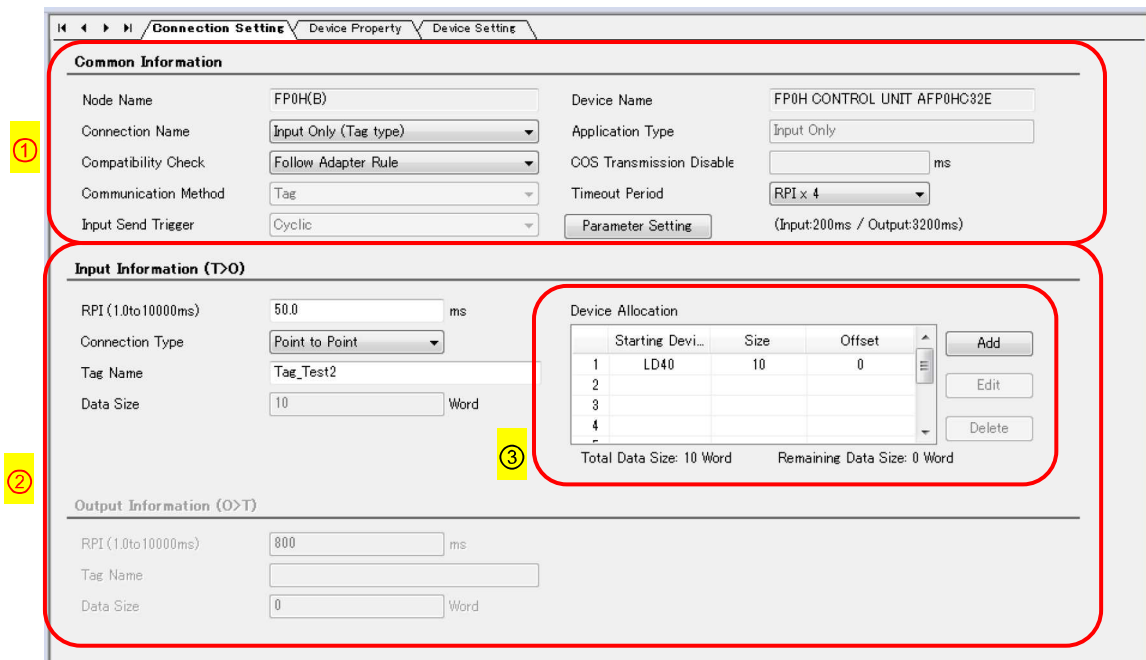

(1) Common information

Item	Description
Node Name	Shows the node name of the target. The node name can be changed in "Device Setting".
Device Name	Shows the device name of the target.
Connection Name	Select from the connection settings registered in EDS files. When the target is FP0H, the communication method (Tag or Instance) can be selected. Tag: Input Only (Tag type) / Instance: Input Only (ID type) Depending on target devices, select the application type.
Application Type	The application type of a selected connection setting is displayed. Example) Exclusive Owner, Input Only
Compatibility Check	Set the operation method of "Compatibility Check" which check the information of the connected target device against the revision of the EDS file. Select from Check, Not Check and Follow Adapter (Target) Rule.
Communication method	Shows the set communication method (Tag/Instance).
Timeout period	Set the communication timeout period of cyclic communication. In the cyclic communication, transmission data is sent as UDP packet. The timeout is judged on a receiver side. The timeout period should be 10 msec or more. RPI can be specified for T>O direction and O>T direction separately, so each timeout period may be different values. The timeout period is selected from the range of 4 (RPI x 4), 8 (RPI x 8), 16 (RPI x 16), 256 (RPI x 256) and 512 (RPI x 512) times of RPI.

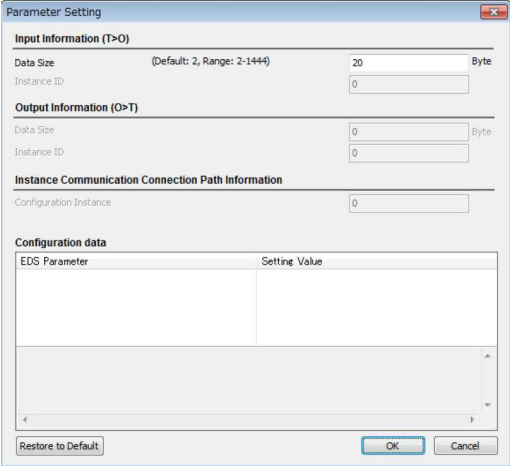
<p>Input Send Trigger</p>	<p>The timing that the target sends data is selected from Cyclic or COS (Change of state). COS is basically a cyclic communication, however, it also performs transmission when sent data changes.</p> <p>Some devices do not support COS. The FP0H does not support COS.</p>
<p>COS Transmission Disable Time</p>	<p>Transmission disable time (RPI of input information x 1/4) is displayed when "Input Send Trigger" is set to "Change of State (COS)". Even if the unit detects the change in data, it is not sent within the transmission disable time.</p>
<p>Parameter setting</p>	<p>Parameter setting window appears by pressing the [Parameter Setting] button. Following screen is example of FP0H.</p>  <p>Parameters defined in the EDS file can be set.</p> <ul style="list-style-type: none"> - The data size of Input Information (T>O) or Output Information (O<T) can be changed. - The instance ID can be changed (Only for target devices that can be changed). - Others (Defined in the EDS file)

**(2) Input Information (T>O): Target to Originator
 (Output Information (O>T): Originator to Target *Available for Exclusive Owner only)**

Item	Description
RPI	Set the transmission interval for the cyclic communication. The usable RPI range depends on target devices.
Connection Type	Select a communication method that is selectable for the selected connection. Point to Point / Multicast
Tag Name/Instance ID	The items vary according to the communication method of each connection. - For "Tag": Set a tag name. - For "Instance": The instance ID is displayed. (It cannot be changed.)
Data Size	Shows the data size entered in "Parameter Setting" in word unit.
Device Allocation	* For allocating devices manually, set "Auto Allocation" in "EtherNet/IP Basic Configuration" to "No". It is possible to "Add", "Edit" or "Delete" devices allocated in the send area or receive area. The data size is changed in [Parameter Setting]. (The details are as follows.)

(3) Device Allocation

Up to eight device allocations can be registered for send or receive of each connection. The maximum number of words that is available for device allocation is 16k words in total.

(Allocation cannot be performed beyond 16,384 words.)

When selecting "Add" or "Edit", the following settings are available.

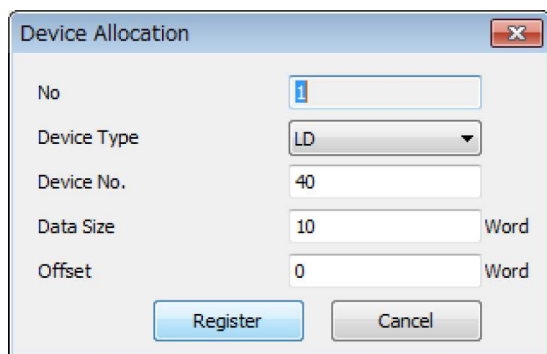

Item	Description																				
No.	Shows the device registration number.																				
Device Type	Select Device Type from WX, WY, WR, WL, DT and LD.																				
Device No.	Set the starting number of the device. Data Size: Set the data size secured from the device number. (Example) When Device Type is "WL", Device No. is "20" and Data Size is "20", WL20 to 39 are secured as the device allocation area.																				
Offset	Set "Offset" when allocating devices after no.2. (Example) When the data size of device no.1 is "20 words", the data size of device no.2 is "10 words" and the data size of device no.3 is "10 words", Set the offset of device no.2 to "20 words" and the offset of device no.3 to "30 words". <div style="border: 1px solid black; padding: 5px; width: fit-content;"> <p>Device Allocation</p> <table border="1" style="width: 100%; border-collapse: collapse;"> <thead> <tr> <th></th> <th>Starting Devi...</th> <th>Size</th> <th>Offset</th> </tr> </thead> <tbody> <tr> <td>1</td> <td>LD0</td> <td>20</td> <td>0</td> </tr> <tr> <td>2</td> <td>WL0</td> <td>10</td> <td>20</td> </tr> <tr> <td>3</td> <td>WX0</td> <td>10</td> <td>30</td> </tr> <tr> <td>4</td> <td></td> <td></td> <td></td> </tr> </tbody> </table> <div style="display: flex; justify-content: flex-end; gap: 10px; margin-top: 5px;"> <input type="button" value="Add"/> <input type="button" value="Edit"/> <input type="button" value="Delete"/> </div> <p style="font-size: small; margin-top: 5px;">Total Data Size: 40 Word Remaining Data Size: 0 Word</p> </div>		Starting Devi...	Size	Offset	1	LD0	20	0	2	WL0	10	20	3	WX0	10	30	4			
	Starting Devi...	Size	Offset																		
1	LD0	20	0																		
2	WL0	10	20																		
3	WX0	10	30																		
4																					

4.3.3 Operations in I/O Map Setting Screen

The operations in "I/O Map Setting" are as follows.

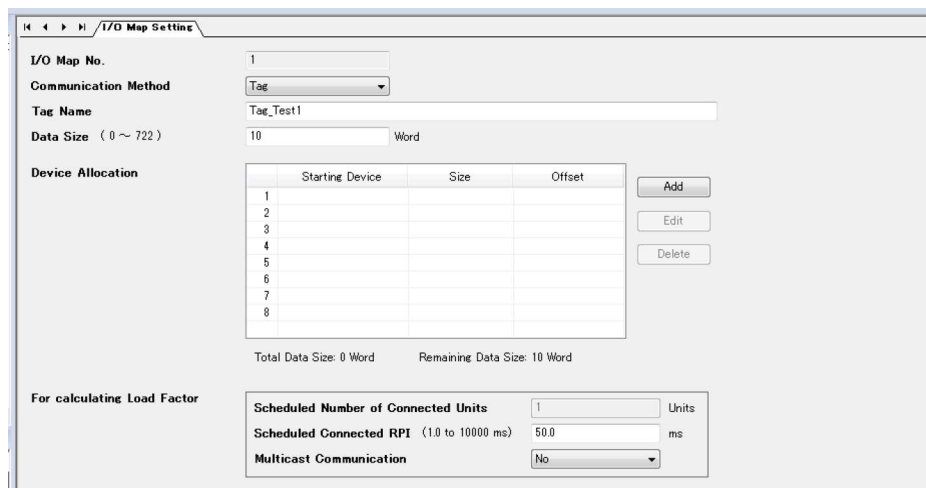

Item	Description
I/O Map No.	Shows the I/O map number currently being set.
Communication method	Set the communication method (Tag/Instance)with originator.
Tag Name/Instance ID	Set a tag name when Communication Method is set to Tag. Set the instance ID Communication Method is set to Instance.
Data Size	Set the data size sent to originator.
Device Allocation	* For allocating devices manually, set "Auto Allocation" in "EtherNet/IP Basic Configuration" to "No". It is possible to "Add", "Edit" or "Delete" devices allocated in the send area. (Refer to p.4-12.)

The following items are used only for the load factor calculation. In the actual communication, the settings specified for originator are used.

Item	Description
Scheduled Number of Connected Units	Set the scheduled number of connections from other originators. (Only when setting "Multicast Communication" to "Yes")
Scheduled Connected RPI	Set an RPI value to be used when connecting originators.
Multicast Communication	Set Multicast Communication (Yes/No).

4.3.4 Display Contents of Calculate Load Factor Screen

The display contents of the Calculate Load Factor screen are as follows.

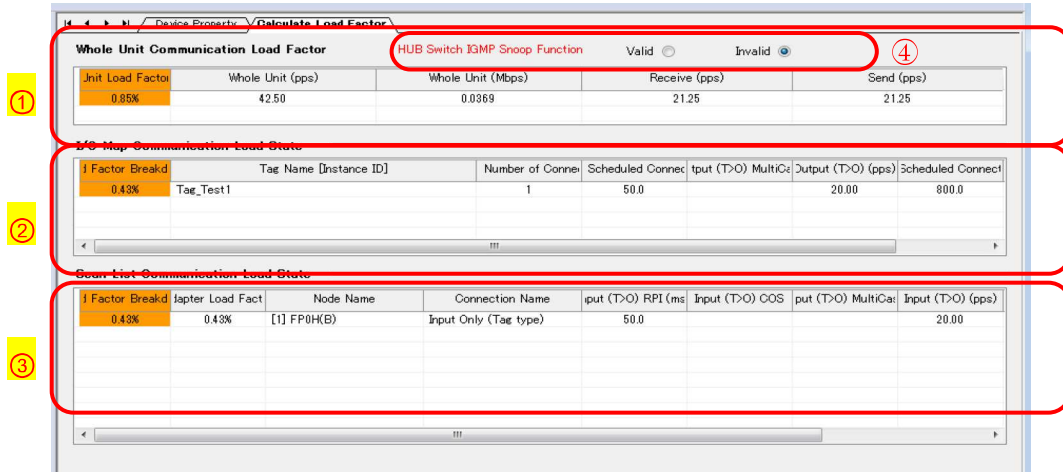

(1) Whole Unit Communication Load Factor

Item	Description
Unit Load Factor	Shows the the communication load factor (%) of the whole unit.
Whole Unit (pps)	Shows the communication volume per second "the total of Receive (pps) and Send (pps)" used for the whole unit in pps unit.
Whole Unit (Mbps)	Shows the communication volume per second used for the whole system in Mbps. The size including preamble, each header size, FCS and IFG (12 bytes) is calculated.
Receive (pps)	Shows the communication volume per second in the receiving direction used for the whole unit "the total of I/O map communication output T>O (pps) and scan list input T>O (pps) in pps unit.
Send (pps)	Shows the communication volume per second in the sending direction used for the whole unit "the total of I/O map communication input O<T (pps) and scan list output O<T (pps) in pps unit.

(2) I/O Map communication Load State

Shows the calculation result of the communication load of the communication in which the FPOH is target.

Item	Description	
Load Factor Breakdown	Shows the unit load factor of each tag (each instance) for each I/O map.	
Tag Name [Instance ID]	Shows the tag name or instance ID.	
Scheduled Number of Connected Units	Shows the scheduled number of connected units.	
Output (T>O)	Scheduled Connected RPI (ms)	Shows the set scheduled connected RPI.
	MultiCast	Shows "●" when setting Multicast Communication to "Yes".
	(pps)	Shows the communication volume (pps) calculated in Scheduled Connected RPI.
Input (O>T)	Scheduled Connected RPI (ms)	Shows the value that is 16 times output (T>O) RPI. (Note 1)
	(pps)	Shows the communication volume (pps) calculated in Scheduled Connected RPI.

(Note 1): When the value that is 16 times RPI (ms) is 10 s or more, RPI is calculated as 10 s.

(3) Scan List Communication Load State

Shows the calculation result of the communication load of the communication in which the FP0H is originator.

Item		Description
Load Factor Breakdown		Shows the load factor breakdown of each target.
Adapter (Target) Load Factor		The load factor calculated from the communication band defined in EDS files of each target.
Node Name		Shows a node number and node name.
Connection Name		Shows a connection name.
Scheduled Number of Connected Units		The scheduled number of connected units is displayed.
Input (T>O)	RPI (ms)	The RPI (communication interval) in the receiving direction of connection settings is displayed.
	COS	When "Input Send Trigger" is set to "Change of State", '●' is displayed.
	MultiCast	When "Connection Type" is set to "Multicast", "●" is displayed.
	(pps)	Shows the communication volume (pps) per second in the receiving direction.
Output (O>T)	Scheduled Connected RPI (ms)	Shows the RPI (communication interval) in the sending direction set in "Connection Setting".
	(pps)	Shows the communication volume (pps) per second in the sending direction.

(4) HUB Switch IGMP Snoop Function

Select make the function "Valid" or "Invalid" when calculating the load factor. When selecting "Invalid", "HUB Switch IGMP Snoop Function" is displayed in red.

* If the adapter (target) load factor exceeds 100% when setting the multicast communication, change the set value of RPI longer or use a HUB that the IGMP snoop function is enabled.

4.3.5 Display Contents of Device Property Screen

The device property information registered in the EDS file can be confirmed.

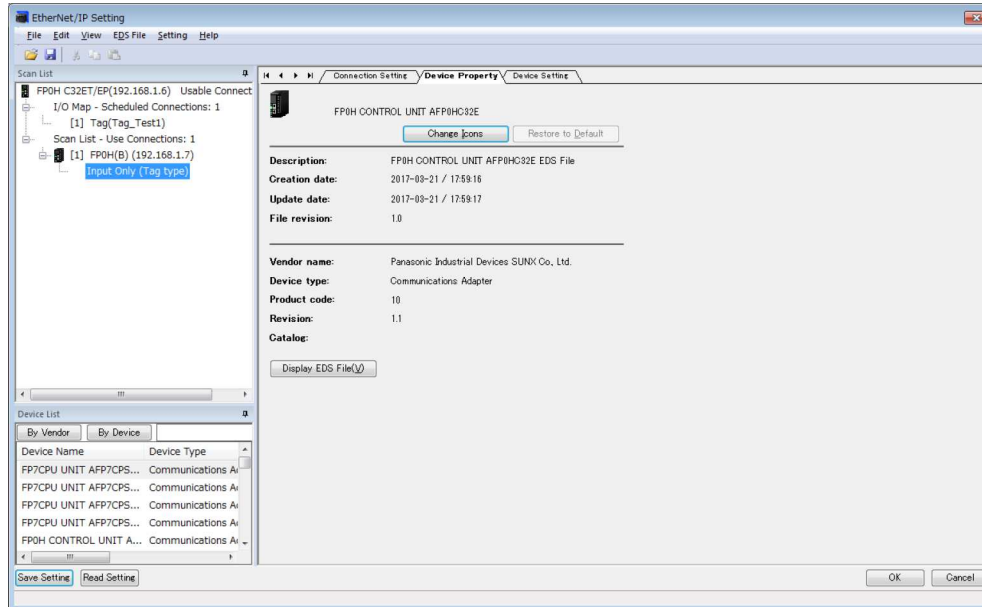

Display item	Description
Icon	Shows the device icon set in the EDS file. When EDS files are unregistered, "?" is displayed. It is possible to "Change Icons" or "Restore to Default".
Display EDS File	Shows the EDS file.

4.3.6 Switching Tabs in Each Setting Screen

By switching the tabs on each setting screen, the displayed screen can be changed.

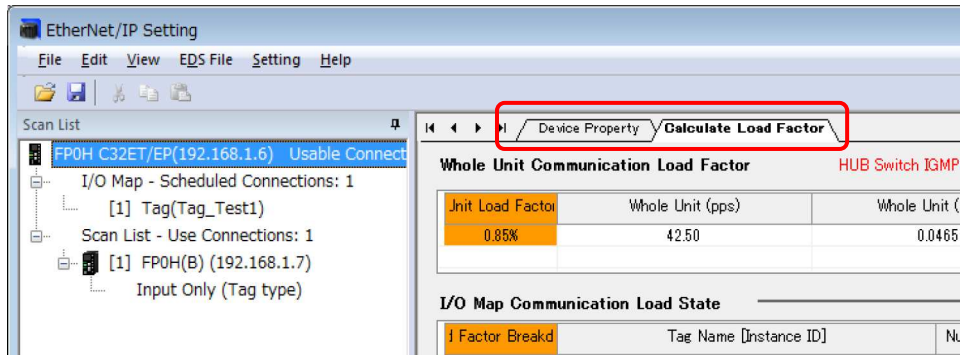

Displayed screen	Switchable screens
Calculate Load Factor	"Calculate Load Factor", "Device Property (Home unit)"
Device Setting	"Device Setting", "Device Property (Selected node)"
Connection Setting	"Connection Setting", "Device Setting", "Device Property (Selected node)"

5

Startup and Operation

5.1 Startup Operation of Cyclic Communication

5.1.1 When FP0H is Originator

When the FP0H is originator, the FP0H operates in the following order after it is powered on.

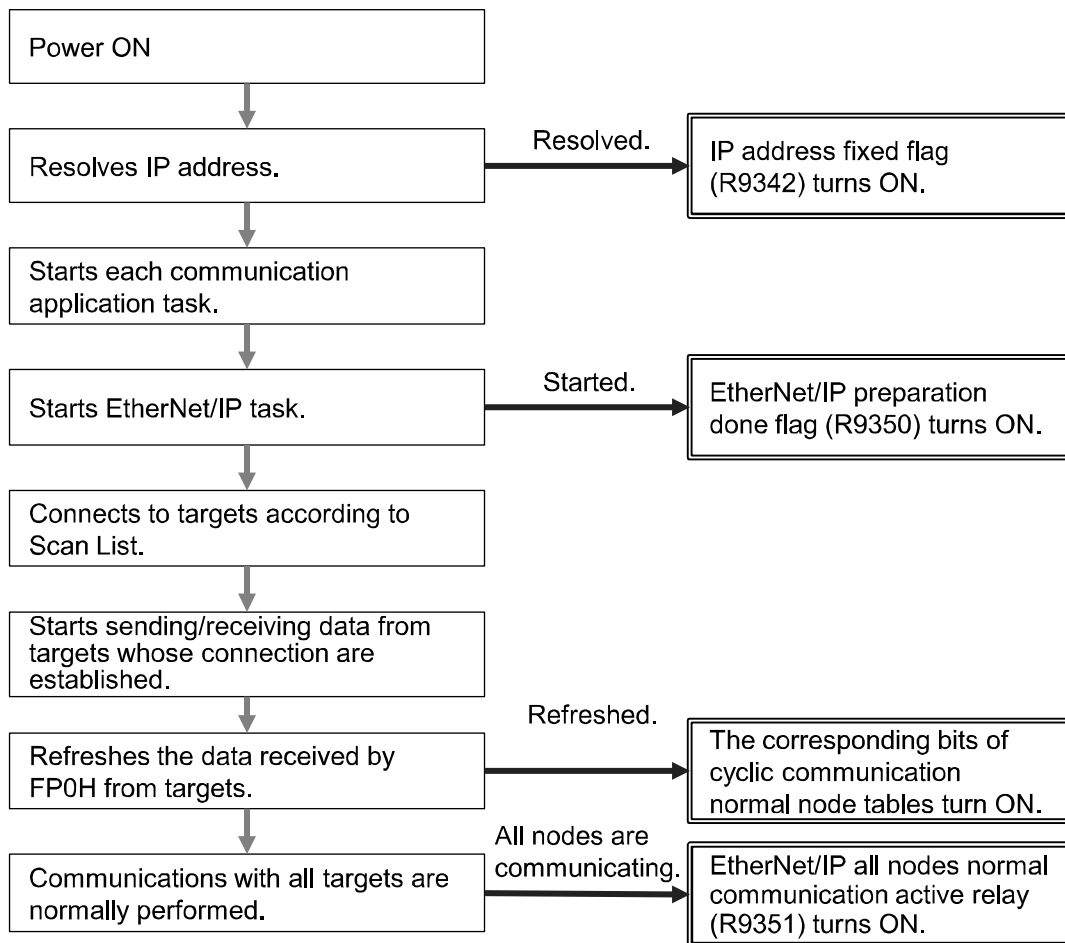

KEY POINTS

- For confirming if the connection with each target is established or not, check "Cyclic communication normal node table". The cyclic communication state node table can be read by F465 ETSTAT instruction. The communication state of each connection can be checked.
- For confirming that the connections with all targets have been established, check the all nodes normal communication active relay (R9351).



NOTES

- **Note when starting the system using the EtherNet/IP function at high speed:**
When the power supply of an Ethernet switch is turned ON at the same time as the start of the system, a normal switch (unmanaged) is activated in a few seconds. However, as for a managed switch, it takes several tens of seconds.
Until the switch is activated, the EtherNet/IP communication cannot be started.
For starting the system at high speed, turn on the power supply of the Ethernet switch in advance, and start the system.

5.1.2 When FP0H is Target

When the FP0H is target, the FP0H operates in the following order after it is powered on.

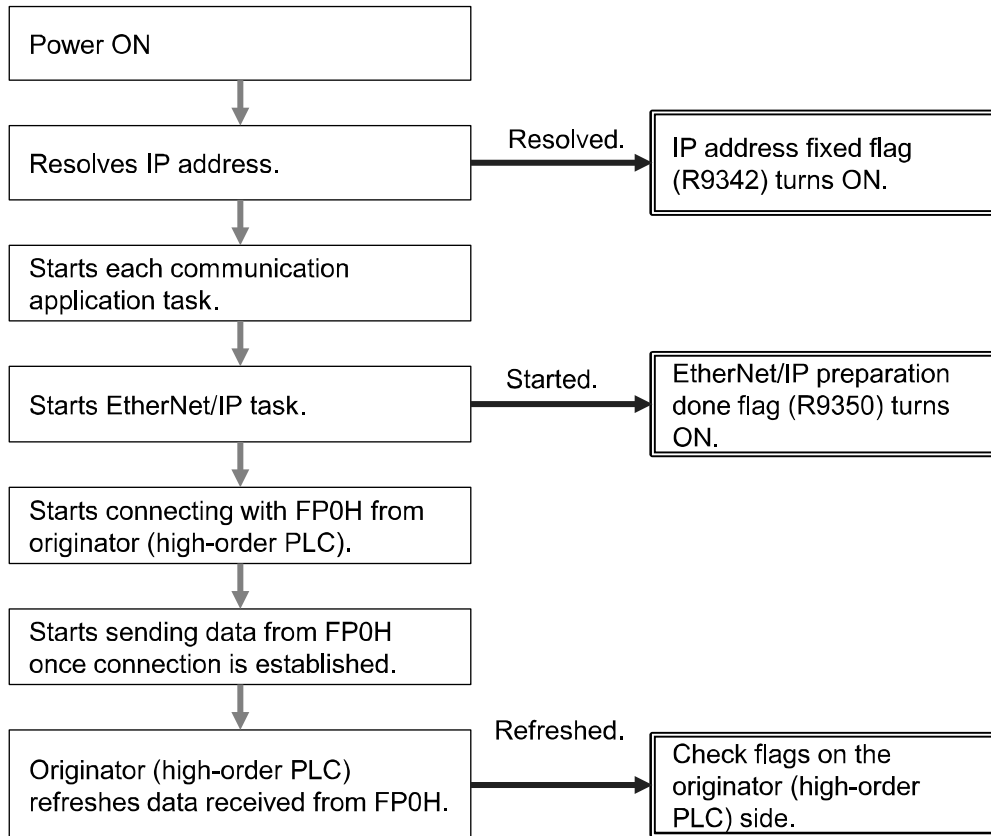

◆ KEY POINTS

- The establishment state of the connection using the FP0H as target cannot be checked from the FP0H. Confirm the communication state by the high-order PLC (originator).

5.2 Checking EtherNet/IP Communication State

5.2.1 Unit Annunciation Relays

There are the following unit annunciation relays.

Device	Description
R9350	EtherNet/IP preparation done = 1, Other states = 0
R9351	Cyclic communication: All nodes communicating normally =1, Others = 0
R9352	Cyclic communication: All nodes stop =1, Others = 0
R9353	Communication abnormal node exists = 1, None = 0
R9354	EtherNet/IP Start/Stop controllable = 1, Uncontrollable = 0

5.2.2 Cyclic Communication State Tables of EtherNet/IP

There the following types of cyclic communication state tables. They can be monitored by reading the states using F465 ETSTAT instruction.

Table type	Description
Cyclic communication registration node table	Bit corresponding to the node number that the connection is registered =1, Invalid node = 0
Cyclic communication normal node table	When the first refresh is complete after connection establishment = 1, Other states = 0
Cyclic communication stop node table	Bit corresponding to the node to be stopped when the stop request processing is complete = 1, Others = 0
Cyclic communication abnormal node table	Node that the cyclic communication error occurs =1, Others = 0
Cyclic communication: RUN/IDLE bit monitor	<p>RUN/IDLE bits received from the targets registered in Scan List</p> <p>When the following two conditions are met, the bit corresponding to each node number turns ON (1). In other conditions, it turns OFF (0).</p> <ul style="list-style-type: none"> - It is communicating with the target node normally. - The RUN/IDLE bit received from the target node is in RUN (1) <p>Note)</p> <p>The communication condition with the FP0H node connected to the source is not reflected.</p>

For details, refer to "6.1.1 Information Acquisition of EtherNet/IP (F465 ETSTAT)".

5.2.3 RUN/IDLE Bit

The RUN/IDLE bit is sent from a PLC or I/O device to indicate the operation state of a device during the cyclic communication. 1 is sent for the RUN state, and 0 is sent for the IDLE state.

■ FP0H operation

The condition that the RUN/IDLE bit becomes the RUN state varies according to the setting of "RUN/IDLE bit operation of cyclic communication" of EtherNet/IP Basic Configuration.

Set	Description
Normal	When the following two conditions are met, it becomes the RUN state. In other conditions, it is in the IDLE state. (1) The FP0H operation mode is RUN mode. (2) It is communicating with all nodes registered in the scan list except the FP0H normally. Select for performing the EtherNet/IP communication with all targets registered in the scan list.
Limited	A value corresponding to the FP0H operation mode is set regardless of the communication state with targets registered in the scan list. FP0H is in RUN mode: RUN FP0H is in PROG mode: IDLE Select this setting for activating only some targets registered in Scan list while others are stopped.



◆ NOTES

- When an originator is in the IDLE state, the connected targets may not operate normally.
- RUN/IDLE bit may not be sent depending on the settings of the EDS files of target devices.

5.3 Judgement and Operation of Abnormality

Abnormality judgement is performed on the following contents.

Abnormality judgement	Description
Cyclic communication start wait time (Abnormality judgement when starting cyclic communication)	If connection is not established when starting the cyclic communication, the operation is retried after the connection timeout period, however, the communication abnormal node flag is set after the elapse of this time. The abnormality judgement is not performed before this time passes. The reconnection is retried automatically even after the determination of the communication abnormal node.

5.4 Delay Time of Communication Data

5.4.1 Delay time of sent data

When a destination device in the cyclic communication controls the data sent from the FP0H to it, each delay time of the FP0H and destination device should be considered.

■ Delay on the FP0H side

A delay caused by the transmission cycle of cyclic communication and the FP0H refresh timing occurs. The delay time on the FP0H side depends on the scan time of the FP0H and the RPI value of the EtherNet/IP communication.

Pattern	Relation between scan time and RPI	Delay time
1	Scan time is smaller than RPI and Scan time x 4 is larger or equal to RPI	Scan time
2	Scan time is smaller than RPI and Scan time x 4 is smaller than RPI	Larger value of scan time x 4 or RPI x 1/16
3	Scan time is nearly equal to RPI	Scan time (RPI)
4	Scan time is larger than RPI	RPI

■ Delay on the destination device side

The delay time on the destination device side is the total of the delays caused by reception processing and output control to output devices.

Delay time of destination device = Delay by reception processing + Delay by output control to output device

* The delay time on the destination device side varies depending on devices. Refer to respective manuals of destination devices.

5.4.2 Delay Time of Reception Data

When the FP0H receives the data sent from a destination device in the cyclic communication, each delay time of the destination device and FP0H should be considered.

■ Delay on the destination device side

The delay time of a destination device is the total of the delays caused by input processing and transmission processing.

Delay time of destination device = Delay by input processing + Delay by transmission processing

* The delay time on the destination device side varies depending on devices. Refer to respective manuals of destination devices.

■ Delay on the FP0H side

A delay caused by the transmission cycle of destination device and the FP0H refresh timing occurs.

The delay time on the FP0H side depends on the scan time of the FP0H and the RPI value of the EtherNet/IP communication.

Pattern	Relation between scan time and RPI	Delay time
1	Scan time is smaller than RPI	Scan time
2	Scan time is nearly equal to RPI	Scan time (RPI) x 2
3	Scan time is larger than RPI	RPI

6

Instruction References

6.1 High-level Instructions Used for EtherNet/IP Control

6.1.1 Information Acquisition of EtherNet/IP (F465 ETSTAT)

■ Instruction format

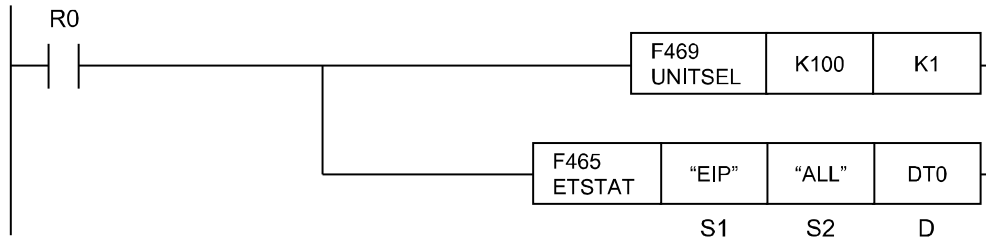

(Note 1): The figure above shows the case of specifying a communication unit slot number (Ethernet communication = K100) using F469 UNITSEL instruction.

(Note 2): By copying and pasting the following text in the instruction list box of FPWIN GR7, the operation part of the above program can be input.
ETSTAT "EIP" "ALL" DT0

■ List of operands

Operand	Description
S1	Specify the type to be read with the starting address or a character constant.
S2	Specify the target to be read with the starting address or a character constant.
D	Specify the starting address of destination.

■ Available devices (●: Available)

Operand	Memory device										Constant			Index modifier	
	WX	WY	WR	WL	SV	EV	DT	LD	I	SWR	SDT	K	H		M
S1	●	●	●	●	●	●	●	●	●					●	●
S2	●	●	●	●	●	●	●	●	●					●	●
D		●	●	●	●	●	●	●	●						●

■ **Processing**

- Reads the parameter information or status information specified by [S1] and [S2], and stores it in the area starting with [D].
- The number of words in the storage area starting with [D] varies according to the type of read data and the target.

■ **Precautions during programming**

- When specifying a device for an operand which can specify character constants, set string data using F253 SSET instruction in advance.
- When specifying string data, the number of characters should not exceed 256.
- Upper and lower case characters can be used for operands which character constant can be specified.
("Abcd", "ABCD" and "abcd" are synonymous, however, the file names are differentiated.)
- Insert the F469 UNITSEL instruction immediately before this instruction and specify the unit (Ethernet communication) and the connection number.
- In [S1] and [S2], specify the starting address of the device storing the string data which indicates the set parameters or a character constant. When specifying a device for an operand, set string data using F253 SSET instruction in advance.
- Both upper and lower case characters can be used. "Abcd", "ABCD" and "abcd" are all synonymous.
- This instruction is not available in interrupt programs.

■ **Specification of [S1] and [S2]**

Item	Description		
S1	Read type	For specifying the read of the EtherNet/IP communication state	Specify "EIP".
S2	Read target	For specifying the communication state of EtherNet/IP	Specify "ALL" or "ALL + Number".
		For specifying the cyclic communication registration node table	Specify "NODE".
		For specifying the cyclic communication normal node table	Specify "NORMAL".
		For specifying the cyclic communication stop node table	Specify "STOP".
		For specifying the cyclic communication abnormal node table	Specify "ERR".
		For specifying the RUN/IDLE bit monitor (PLC standby flag)	Specify "PLC".

■ **Specification of [S2] and objects to be read**

- The read contents vary according to the character string set in [S2].
- The number of read words varies according to the maximum registered node number.

Name	No. of words (Note 1)	Character string set in [S2] and read object (●: Read, Blank: Not read)						
		ALL	ALL + Number (0 to 1) (Note 2)	NODE	NORMAL	STOP	ERR	PLC
Registered max. node number	1	●	●	●	●	●	●	●
Cyclic communication Registered node table (Note 3)	0 to 1	●	●	●				
Cyclic communication Normal node table (Note 3)	0 to 1	●	●		●			
Cyclic communication Stop node table (Note 3)	0 to 1	●	●			●		
Cyclic communication Abnormal node table (Note 3)	0 to 1	●	●				●	
RUN/IDLE bit monitor (PLC standby flag) (Note 3)	0 to 1	●	●					●
No. of read words (Note 1)		1 to 6	1 to 6	1 to 2	1 to 2	1 to 2	1 to 2	1 to 2

(Note 1): The number of read words varies according to the registered maximum node number.

Max. node no.	No. of valid words
0	0
1 to 9	1

(Note 2): When specifying "ALL + Number (0 to 1)" for [S2], the information for the number of effective words specified by the number is read.

(Note 3): The bits in the following table are allocated to the node table numbers and RUN/IDLE bit monitor.

Node no.	Bit No.															
	15	14	13	12	11	10	9	8	7	6	5	4	3	2	1	0
	—	—	—	—	—	—	—	9	8	7	6	5	4	3	2	1

■ **Restrictions on combinations of operands [S1] and [S2]**

"A" in the table below indicates the available combinations. An operation error occurs when other combinations are specified.

		S2					
		ALL	NODE	NORMAL	STOP	ERR	PLC
S1	EIP	A	A	A	A	A	A

- Read content 1 (When S1 is "EIP" and S2 is "ALL" or "ALL + Number": 1 to 6 words)

Name	No. of words	Description
Max. registration node number	1	Registered maximum node number
Cyclic communication registration node table	0 to 1 (Note 1) (Note 2)	Node that connection is registered
Cyclic communication normal node table	0 to 1 (Note 1) (Note 2)	Node that the cyclic communication is performed normally
Cyclic communication stop node table	0 to 1 (Note 1) (Note 2)	Node that the cyclic communication stops
Cyclic communication abnormal node table	0 to 1 (Note 1) (Note 2)	Node that the cyclic communication error occurs
RUN/IDLE bit monitor (PLC standby flag)	0 to 1 (Note 1) (Note 2)	RUN/IDLE bit monitor of 32-bit header

- Read content 2 (When S1 is "EIP" and S2 is "NODE": 1 to 2 words)

Name	No. of words	Description
Max. registration node number	1	Registered maximum node number
Cyclic communication registration node table	0 to 1 (Note 1)	Node that connection is registered

- Read content 3 (When S1 is "EIP" and S2 is "NORMAL": 1 to 2 words)

Name	No. of words	Description
Max. registration node number	1	Registered maximum node number
Cyclic communication normal node table	0 to 1 (Note 1)	Node that the cyclic communication is performed normally

- Read content 4 (When S1 is "EIP" and S2 is "STOP": 1 to 2 words)

Name	No. of words	Description
Max. registration node number	1	Registered maximum node number
Cyclic communication stop node table	0 to 1 (Note 1)	Node that the cyclic communication stops

Instruction References

- Read content 5 (When S1 is "EIP" and S2 is "ERR": 1 to 2 words)

Name	No. of words	Description
Max. registration node number	1	Registered maximum node number
Cyclic communication abnormal node table	0 to 1 (Note 1)	Node that the cyclic communication error occurs

- Read content 6 (When S1 is "EIP" and S2 is "PLC": 1 to 2 words)

Name	No. of words	Description
Max. registration node number	1	Registered maximum node number
RUN/IDLE bit monitor of 32-bit header	0 to 1 (Note 1)	RUN/IDLE bit monitor of 32-bit header

(Note 1): The number of words varies according to the registered maximum node number.

Max. node no.	No. of valid words
0	0
1 to 9	1

(Note 2): When specifying "ALL + Number" for [S2], the number of valid words is the specified number.
The numbers are 0 to 1.

- Allocation of bit numbers and node numbers of each table and monitor

Correspondence table of node numbers																
Bit no.	15	14	13	12	11	10	9	8	7	6	5	4	3	2	1	0
Node no.	—	—	—	—	—	—	—	9	8	7	6	5	4	3	2	1

■ **Setting example**

Example 1) When specifying the reading of EtherNet/IP communication state

[S1]... "EIP" [S2]... "ALL" [D]...DT20

	Value	
DT20	9	Max. registration node number
DT21	0000 0001 1111 1111	Cyclic communication registration node table (Node nos. 1 to 9)
DT22	0000 0000 1011 1111	Cyclic communication normal node table (Node nos. 1 to 9)
DT23	0000 0001 0100 0000	Cyclic communication stop node table (Node nos. 1 to 9)
DT24	0000 0000 0100 0000	Cyclic communication abnormal node table (Node nos. 1 to 9)
DT25	0000 0000 0000 1111	RUN/IDLE bit monitor (PLC standby flag) (Node nos. 1 to 9)

Example 2) When specifying the reading of EtherNet/IP communication state

When the maximum registered node number is "0", only the value of [D] is updated and the values after [D+1] are not updated.

[S1]... "EIP" [S2]... "ALL" [D]...DT20

	Value	
DT20	0	Max. registration node number

Example 3) When specifying the reading of EtherNet/IP communication state (fixing the number of valid words)

The communication states of node numbers 1 to 9 are displayed regardless of the maximum registered node number.

[S1]... "EIP" [S2]... "ALL+1" [D]...DT20

	Value	
DT20	9	Max. registration node number
DT21	1st word	Cyclic communication registration node table (Node nos. 1 to 9)
DT22	1st word	Cyclic communication normal node table (Node nos. 1 to 9)
DT23	1st word	Cyclic communication stop node table (Node nos. 1 to 9)
DT24	1st word	Cyclic communication abnormal node table (Node nos. 1 to 9)
DT25	1st word	RUN/IDLE bit monitor (PLC standby flag) (Node nos. 1 to 9)

Example 4) When specifying the reading of cyclic communication registration node table

[S1]... "EIP" [S2]... "NODE" [D]...WR100

	Value	
WR100	9	Max. registration node number
WR101	0000 0001 1111 1111	Cyclic communication registration node table (Node nos. 1 to 9)

Instruction References

Example 5) When specifying the reading of cyclic communication registration node table

When the maximum registered node number is "0", only the value of [D] is updated and the values after [D+1] are not updated.

[S1]... "EIP" [S2]... "NODE" [D]...WR100

	Value
WR100	0

Max. registration node number

Example 6) When specifying the reading of cyclic communication normal node table

[S1]... "EIP" [S2]... "NORMAL" [D]...WY100

	Value
WY100	7
WY101	0000 0000 0111 1111

Max. registration node number

Cyclic communication normal node table (Node nos. 1 to 9)

Example 7) When specifying the reading of cyclic communication normal node table

When the maximum registered node number is "0", only the value of [D] is updated and the values after [D+1] are not updated.

[S1]... "EIP" [S2]... "NORMAL" [D]...WY100

	Value
WY100	0

Max. registration node number

Example 8) When specifying the reading of cyclic communication stop node table

[S1]... "EIP" [S2]... "STOP" [D]...WR10

	Value
WR10	8
WR11	0000 0000 1111 1111

Max. registration node number

Cyclic communication stop node table (Node nos. 1 to 9)

Example 9) When specifying the reading of cyclic communication stop node table

When the maximum registered node number is "0", only the value of [D] is updated and the values after [D+1] are not updated.

[S1]... "EIP" [S2]... "STOP" [D]...WR10

	Value
WR10	0

Max. registration node number

Example 10) When specifying the reading of cyclic communication abnormal node table

[S1]... "EIP" [S2]... "ERR" [D]...WR100

	Value
WR100	5
WR101	0000 0000 0000 1000

Max. registration node number

Cyclic communication abnormal node table (Node nos. 1 to 9)

Example 11) When specifying the reading of cyclic communication abnormal node table

When the maximum registered node number is "0", only the value of [D] is updated and the values after [D+1] are not updated.

[S1]... "EIP" [S2]... "ERR" [D]...WR100

	Value
WR100	0

Max. registration node number

Example 12) When specifying the reading of RUN/IDLE bit monitor (PLC standby flag)

[S1]... "EIP" [S2]... "PLC" [D]...WR200

	Value
WR200	9
WR201	0000 0001 1111 1111

Max. registration node number

RUN/IDLE bit monitor (Node nos. 1 to 9)

Example 13) When specifying the reading of RUN/IDLE bit monitor (PLC standby flag)

[S1]... "EIP" [S2]... "PLC" [D]...WR200

When the maximum registered node number is "0", only the value of [D] is updated and the values after [D+1] are not updated.

	Value
WR200	0

Max. registration node number

■ Flag operation

Name	Description
Hold error (R9007) Latest error (R9008)	Set when the read area is out of the range.
	Set when the read type (S1) is set to an item other than "IPv4" or "EIP".
	Set when the target to be read (S2) is set to an item other than "MAC", "CONNECT", "ALL", "NODE", "NORMAL", "STOP", "ERR" or "PLC".
	Set when a combination other than the combinations listed in the restrictions on combination is specified for the type (S1) and target (S2) to be read.
	Set when the unit specified by F469 UNITSEL is not the Ethernet communication.
	Set when executed in an interrupt program.

7

Reference Information

7.1 Calculation Method of Load Factor

The communication load factor is a value obtained by dividing the number of communication packets that an EtherNet/IP device sends/receives per second by a cyclic communication allowable communication band (the number of packets that can be sent/received per second).



NOTES

The load factors of FP0H and each target should be 100% or less.

■ Load factor of FP0H

$$\text{Unit communication load factor} = \frac{\text{Number of communication packets sent/received per second (pps)}}{\text{Cyclic communication allowable communication band (pps)}} \times 100\%$$

[Calculation 1] Calculating the number of communication packets sent/received per second (pps)

Calculate from RPI. *1 pps = 1000 / RPI [ms]

When the COS (Change of State) trigger is set, it calculated as a communication cycle RPI x 1/4.

- [Example 1] For the connection that RPI is 1.0 [ms]
1000 / 1.0 = 1000pps
- [Example 2] For the connection that RPI is 1.0 [ms] and the COS trigger is set
1000 / (1.0×(1/4)) = 4000 pps

[Calculation 2] Calculating the cyclic communication allowable communication band (pps)

Calculate from the data size per packet *2 and EDS information [Capacity] for FP0H.

Data size per packet	EDS information for FP0H [Capacity]
2 to 510 bytes	5000 pps
511 to 1450 bytes	2500 pps

*2: Data size per packet

= Connection transmission/reception data size = Raw data size + 32-bit header size *3

*3. The 32-bit header size varies according to the connected target devices.

It is automatically given when calculating the load factor.

Without 32-bit header	2 bytes
With 32-bit header	6 bytes

[Example 3] When the connection transmission raw data size is 256 bytes without 32-bit header

(256 + 2) = 258 bytes ≤ 510 → 5000 pps

- [Example 4] When the connection transmission raw data size is 512 bytes with 32-bit header

(512 + 6) = 518 bytes ≥ 511 → 2500 pps

[Calculation 3] Calculation of unit communication load factor (%)

Calculate it from the number of sent/received packets (pps) and sent/received data size.

- [Example 5] When the number of sent packets is 2000 pps, sent data size is 256 bytes,
the number of received packets is 125 pps, and received data size is 86 bytes

Communication load factor (Send) $2000 \text{ pps} / 5000 \text{ pps} \times 100\% = 40\%$

Communication load factor (Receive) $125 \text{ pps} / 5000 \text{ pps} \times 100\% = 2.5\%$

The unit communication load factor is $(40\% + 2.5\% = 42.5\%)$.

■ **Load factor of target**

The load factor is calculated from the EDS information [Capacity] of each target. When EDS information is not registered, "Impossible to calculate" is displayed.

$$\text{Adapter communication load factor} = \frac{\text{Number of communication packets sent/received per second (pps)}}{\text{Cyclic communication allowable communication band (pps)}} \times 100\%$$

[Calculation 1-1] Calculation of the number of communication packets sent/received per second (pps) *4

The calculation method is the same as [Calculation 1] of unit load factor.

*4 When "HUB Switch IGMP Snoop Function" is "Invalid" and "Connection Type" is "Point to Point", multicast communication packets (pps) are added.

[Calculation 1-2] Calculation of multicast communication packets (pps)

The calculation method is the same as [Calculation 1] of unit load factor.

Packets that "Multicast communication" is set to "Yes" in the I/O map setting and the connection type is "MultiCast" in the connection setting are to be calculated.

[Calculation 2] Calculating the cyclic communication allowable communication band (pps)

Calculate from the data size per packet *2 and EDS information [Capacity] for target.

The calculation method is the same as [Calculation 2] of unit load factor.

[Calculation 3] Calculating the unit communication load factor from the number of sent/received packets (pps) and sent/received data size

Calculate the unit communication load factor from the number of sent/received packets (pps) and sent/received data size.

The calculation method is the same as [Calculation 3] of unit load factor.

<Load factor calculation screen of EtherNet/IP setting tool>

Whole Unit Communication Load Factor

Unit Load Factor	Whole Unit (pps)	Whole Unit (Mbps)	Receive (pps)	Send (pps)
57.98%	2868.75	2.2105	1481.25	1387.50

I/O Map Communication Load State

Load Factor Breakdown	Tag Name [Instance ID]	Number of Conne	Scheduled Conne	Input (T-O) MultiCa	Output (T-O) (pps)	Schedule
4.25%	[100]	1	5.0		200.00	80
21.25%	Tag_2	1	1.0		1000.00	10
2.13%	Tag_3	1	10.0		100.00	16

Scan List Communication Load State

Load Factor Breakdown	Adapter Load Factor	Node Name	Connection Name	Input (T-O) RPI (ms)	Input (T-O) COS	Output (T-O) MultiCa	Inp
2.13%	1.06%	[1] FFX(A)	Input Only (Tag type)	10.0			
21.25%	10.63%	[2] FFX(B)	Input Only (Tag type)	1.0			
4.25%	4.25%	[3] FFX(H)	Input Only (Tag type)	5.0			
2.13%	2.13%	[4] FFX(C)	Input Only (Tag type)	10.0			

7.2 Cyclic Communication: List of Abnormal Statuses

The details of status numbers when cyclic communication errors occur are as follows.

Abnormal status (Hexadecimal)	Status name
0100	CONNECTION IN USE OR DUPLICATE FORWARD OPEN
0103	TRANSPORT CLASS AND TRIGGER COMBINATION NOT SUPPORTED
0106	OWNERSHIP CONFLICT
0107	TARGET CONNECTION NOT FOUND
0108	INVALID NETWORK CONNECTION PARAMETER
0109	INVALID CONNECTION SIZE
0110	TARGET FOR CONNECTION NOT CONFIGURED
0111	RPI NOT SUPPORTED.
0112	RPI VALUE(S) NOT ACCEPTABLE
0113	OUT OF CONNECTIONS
0114	VENDOR ID OR PRODUCT CODE MISMATCH
0115	DEVICE TYPE MISMATCH
0116	REVISION MISMATCH
0117	INVALID PRODUCED OR CONSUMED APPLICATION PATH
0118	INVALID OR INCONSISTENT CONFIGURATION APPLICATION PATH
0119	NON-LISTEN ONLY CONNECTION NOT OPENED
011A	TARGET OBJECT OUT OF CONNECTIONS
011B	THE PRODUCTION INHIBIT TIME IS GREATER THAN THE RPI
011C	TRANSPORT CLASS NOT SUPPORTED
011D	PRODUCTION TRIGGER NOT SUPPORTED
011E	DIRECTION NOT SUPPORTED
011F	INVALID ORIGINATOR TO TARGET NETWORK CONNECTION FIXVAR
0120	INVALID TARGET TO ORIGINATOR NETWORK CONNECTION FIXVAR
0121	INVALID ORIGINATOR TO TARGET NETWORK CONNECTION PRIORITY
0122	INVALID TARGET TO ORIGINATOR NETWORK CONNECTION PRIORITY
0123	INVALID ORIGINATOR TO TARGET NETWORK CONNECTION TYPE
0124	INVALID TARGET TO ORIGINATOR NETWORK CONNECTION TYPE
0125	INVALID ORIGINATOR TO TARGET NETWORK CONNECTION REDUNDANT_OWNER
0126	INVALID CONFIGURATION SIZE
0127	INVALID ORIGINATOR TO TARGET SIZE
0128	INVALID TARGET TO ORIGINATOR SIZE
0129	INVALID CONFIGURATION APPLICATION PATH
012A	INVALID CONSUMING APPLICATION PATH
012B	INVALID PRODUCING APPLICATION PATH
012C	CONFIGURATION SYMBOL DOES NOT EXIST
012D	CONSUMING SYMBOL DOES NOT EXIST

Reference Information

Abnormal status (Hexadecimal)	Status name
012E	PRODUCING SYMBOL DOES NOT EXIST
012F	INCONSISTENT APPLICATION PATH COMBINATION
0130	INCONSISTENT CONSUME DATA FORMAT
0131	INCONSISTENT PRODUCE DATA FORMAT
0132	NULL FORWARD OPEN FUNCTION NOT SUPPORTED
0133	CONNECTION TIMEOUT MULTIPLIER NOT ACCEPTABLE
0203	CONNECTION TIMED OUT
0204	UNCONNECTED REQUEST TIMED OUT
0205	PARAMETER ERROR IN UNCONNECTED REQUEST SERVICE
0206	MESSAGE TOO LARGE FOR UNCONNECTED_SEND SERVICE
0207	UNCONNECTED ACKNOWLEDGE WITHOUT REPLY
0301	NO BUFFER MEMORY AVAILABLE
0302	NETWORK BANDWIDTH NOT AVAILABLE FOR DATA
0303	NO CONSUMED CONNECTION ID FILTER AVAILABLE
0304	NOT CONFIGURED TO SEND SCHEDULED PRIORITY DATA
0305	SCHEDULE SIGNATURE MISMATCH
0306	SCHEDULE SIGNATURE VALIDATION NOT POSSIBLE
0311	PORT NOT AVAILABLE
0312	LINK ADDRESS NOT VALID
0315	INVALID SEGMENT IN CONNECTION PATH
0316	FORWARD CLOSE SERVICE CONNECTION PATH MISMATCH
0317	SCHEDULING NOT SPECIFIED
0318	LINK ADDRESS TO SELF INVALID
0319	SECONDARY RESOURCES UNAVAILABLE
031A	RACK CONNECTION ALREADY ESTABLISHED
031B	MODULE CONNECTION ALREADY ESTABLISHED
031C	MISCELLANEOUS
031D	REDUNDANT CONNECTION MISMATCH
031E	NO MORE USER CONFIGURABLE LINK CONSUMER RESOURCES AVAILABLE IN THE PRODUCING MODULE
031F	NO USER CONFIGURABLE LINK CONSUMER RESOURCES CONFIGURED IN THE PRODUCING MODULE
0800	NETWORK LINK OFFLINE
0810	NO TARGET APPLICATION DATA AVAILABLE
0811	NO ORIGINATOR APPLICATION DATA AVAILABLE
0812	NODE ADDRESS HAS CHANGED SINCE THE NETWORK WAS SCHEDULED
0813	NOT CONFIGURED FOR OFF-SUBNET MULTICAST
0814	INVALID PRODUCE/CONSUME DATA FORMAT

7.3 PLC Link and Ethernet Switch

There are two methods for improve the transmission efficiency with switching hubs.

■ Multicast filter function

This function is used to suppress unnecessary multicast packet transmission.

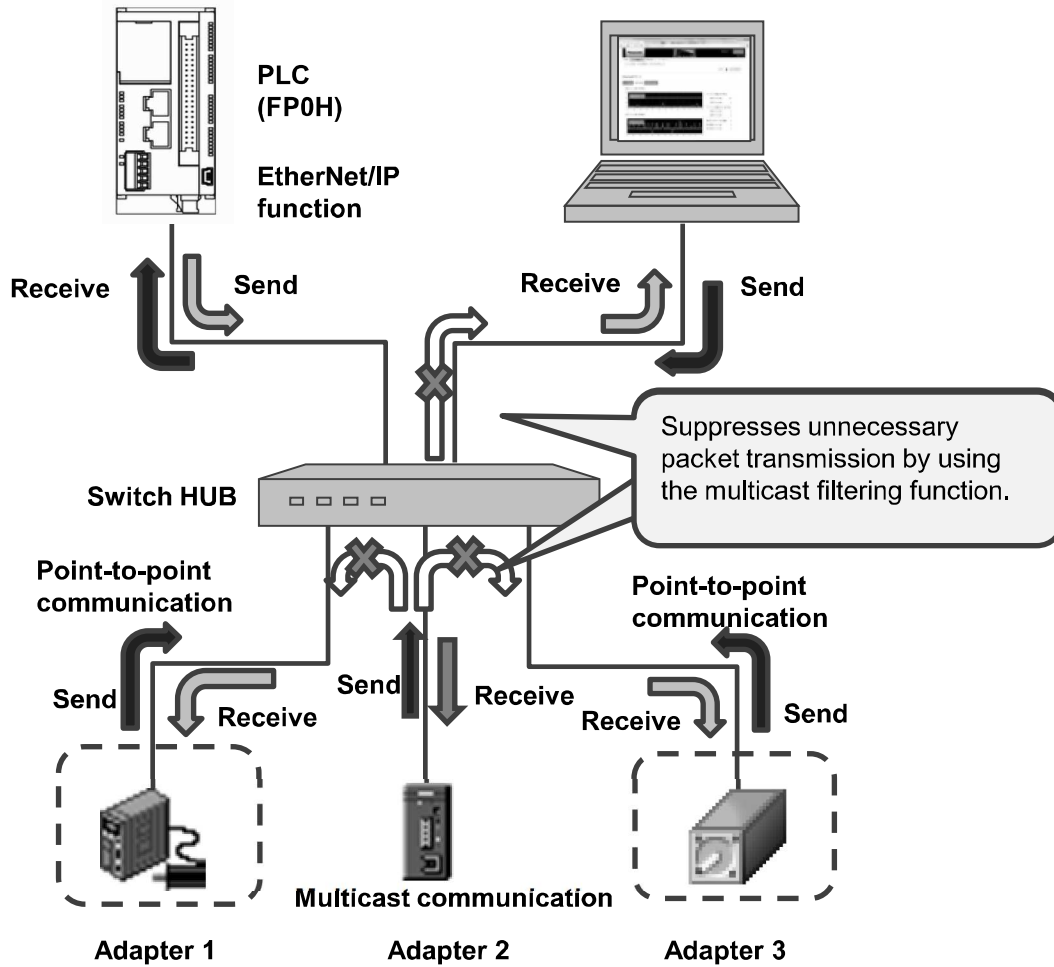

■ QOS (Quality of Service) function

The transmission of EtherNet/IP packets takes a priority over Ethernet communications other than EtherNet/IP communication in the hub.

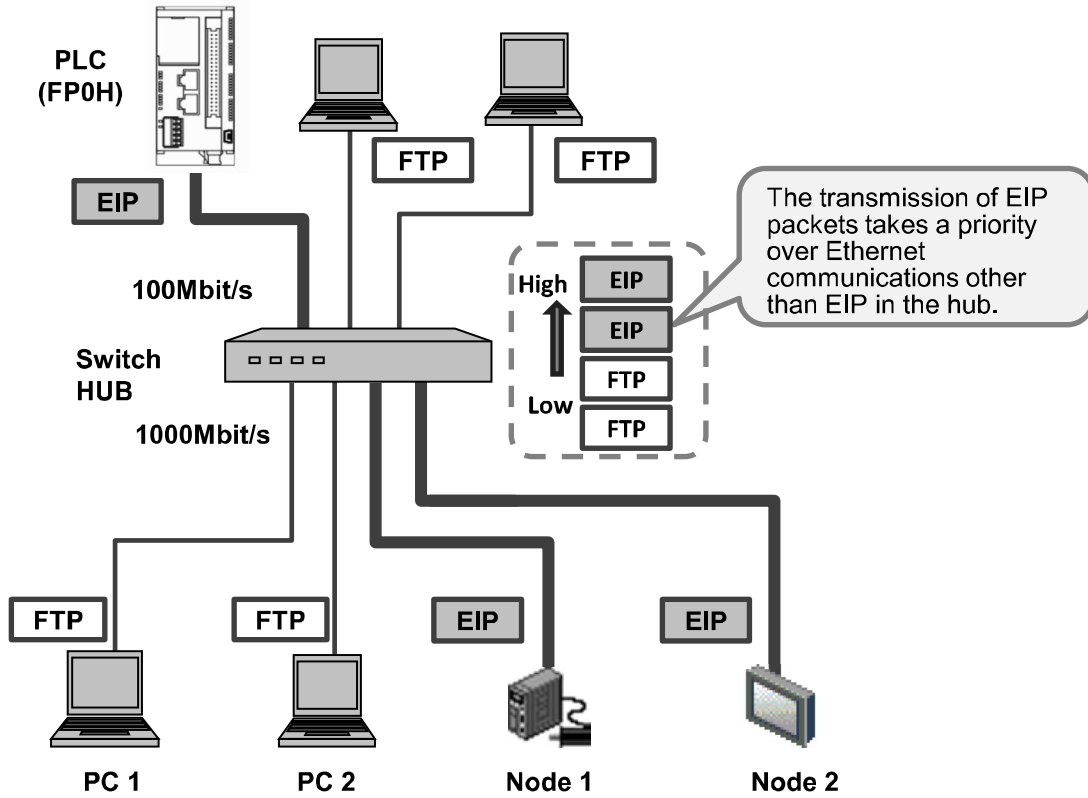

8

Appendix

8.1 Supported Data Types

The following table shows the data types supported by the FPOH control unit. The names and data codes of the supported data types are prescribed by the Common Industrial Protocol (CIP).

Supported data type	Data size	Data code	Description
BOOL	1 byte	C1	Boolean logic with logical values TRUE and FALSE
SINT	1 byte	C2	Signed 8-bit integer value
INT	2 bytes	C3	Signed 16-bit integer value
DINT	4 bytes	C4	Signed 32-bit integer value
LINT	8 bytes	C5	Signed 64-bit integer value
USINT	1 byte	C6	Unsigned 8-bit integer value
UINT	2 bytes	C7	Unsigned 16-bit integer value
UDINT	4 bytes	C8	Unsigned 32-bit integer value
ULINT	8 bytes	C9	Unsigned 64-bit integer value
REAL	4 bytes	CA	32-bit floating-point value
LREAL	8 bytes	CB	64-bit floating-point value
STRING	Variable according to the size of character string	D0	Character string (1-byte character)
BYTE	1 byte	D1	Bit string: 8 bits
WORD	2 bytes	D2	Bit string: 16 bits
DWORD	4 bytes	D3	Bit string: 32 bits
LWORD	8 bytes	D4	Bit string: 64 bits

Record of changes

Manual No.	Date	Record of Changes
WUME-FP0HEIP-01	Oct. 2017	1st Edition
WUME-FP0HEIP-02	Jun. 2018	2nd Edition Responded to the addition of EDS files for EtherNet/IP devices manufactured by Panasonic. Error correction
WUME-FP0HEIP-03	May 2019	3rd Edition "Chapter 8: Appendix" added

Please contact

Panasonic Industrial Devices SUNX Co., Ltd.

■ Overseas Sales Division (Head Office): 2431-1 Ushiyama-cho, Kasugai-shi, Aichi, 486-0901, Japan

■ Telephone: +81-568-33-7861 ■ Facsimile: +81-568-33-8591

panasonic.net/id/pidsx/global

About our sale network, please visit our website.

May, 2019 PRINTED IN JAPAN

© Panasonic Industrial Devices SUNX Co., Ltd. 2019
WUME-FP0HEIP-03